

## PHG C90X3 SKF

Banded classical belt

TYPE: V- belts, Banded belts, Classical, Section 22/C (SKF)

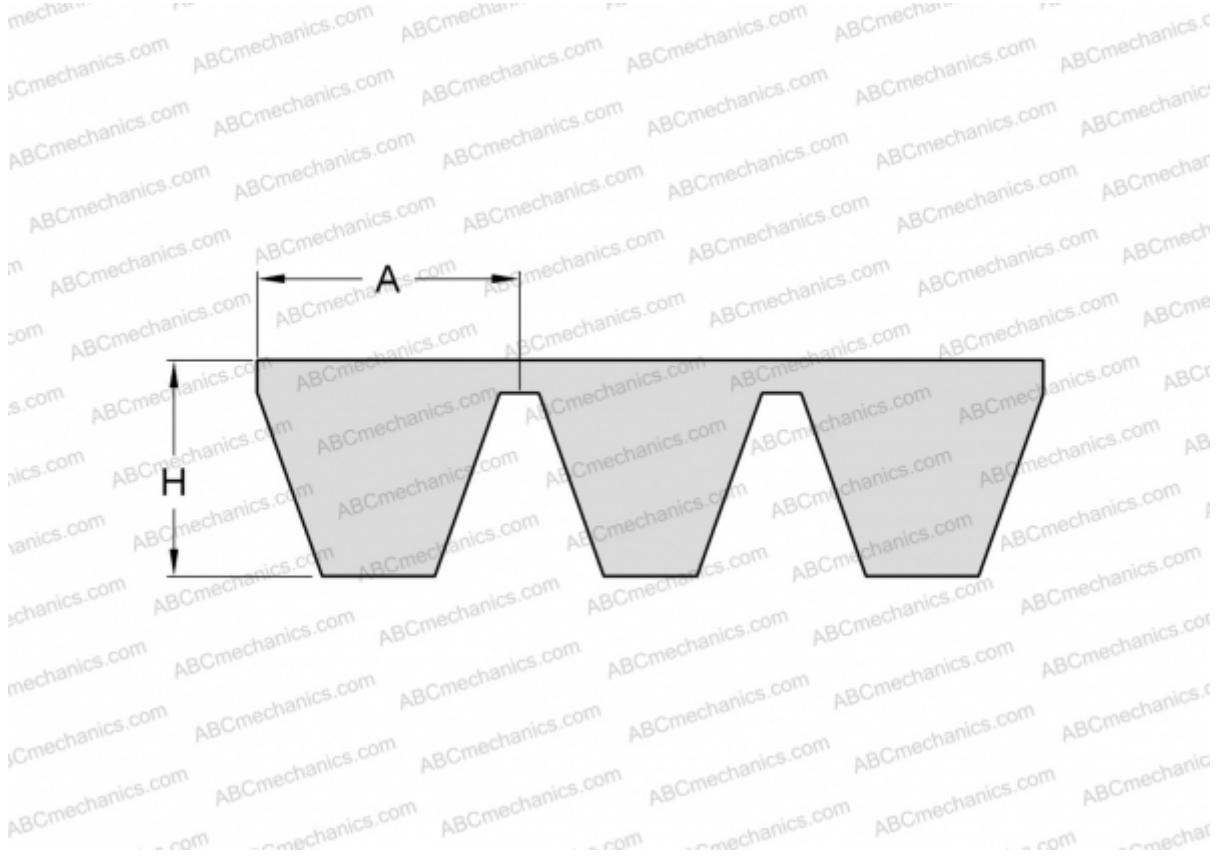

### Technical specification

#### DIMENSIONS, MM

Estimated length	2340,000
Inner length	2286,000
Width, W	66,000
Height, H	16,200
A	22,000

#### MANUFACTURER

[SKF](#)