

PHG C98X3 SKF

Banded classical belt

TYPE: V- belts, Banded belts, Classical, Section 22/C (SKF)

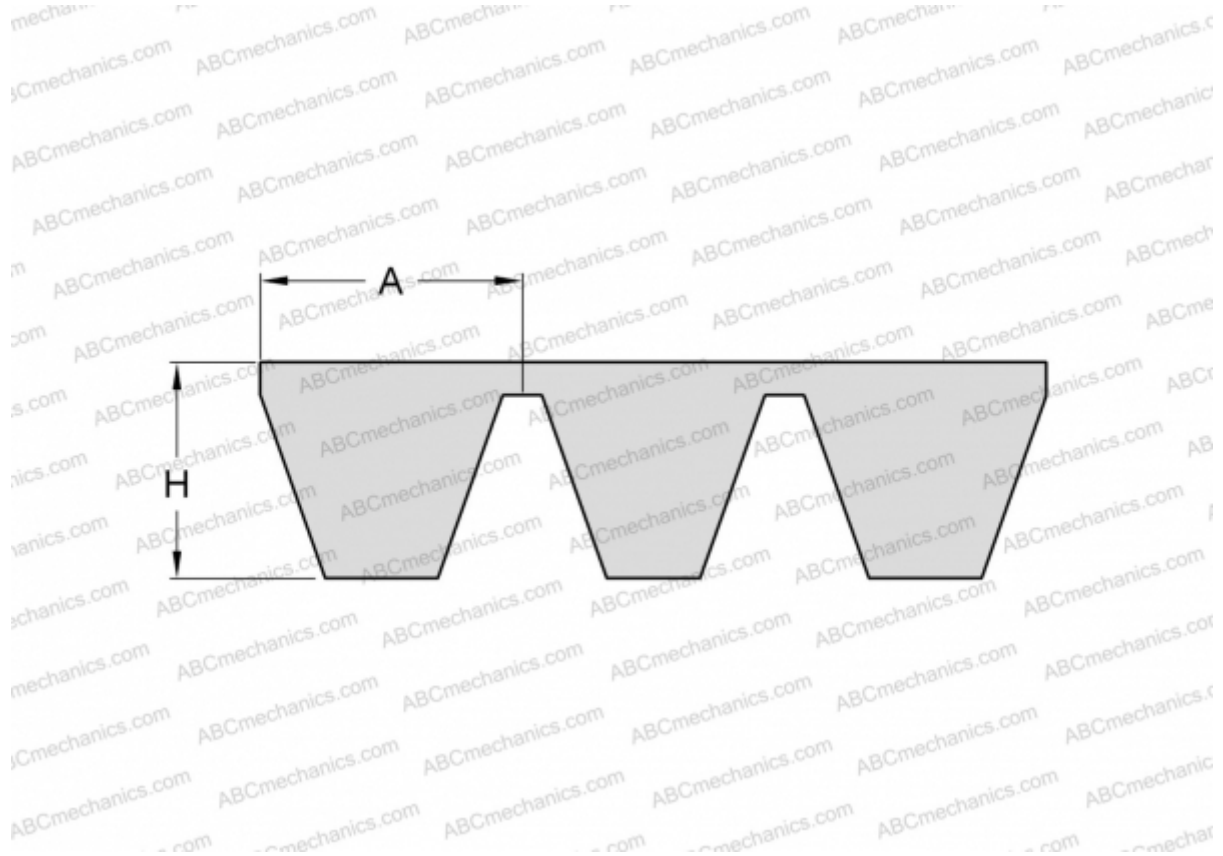

Technical specification

DIMENSIONS, MM

Estimated length	2550,000
Inner length	2489,200
Width, W	66,000
Height, H	16,200
A	22,000

MANUFACTURER

[SKF](#)