

PHG C177X5 SKF

Banded classical belt

TYPE: V- belts, Banded belts, Classical, Section 22/C (SKF)

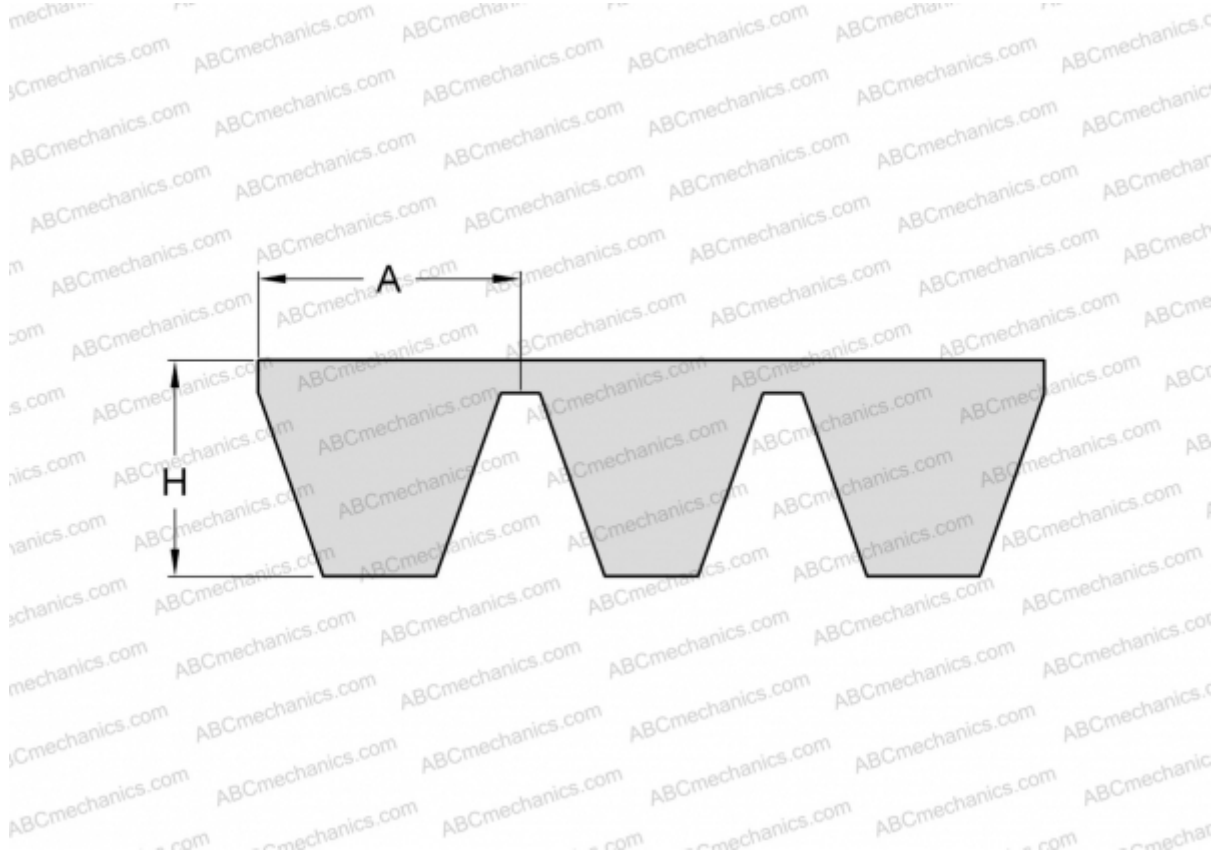

Technical specification

DIMENSIONS, MM

Estimated length	4560,000
Inner length	4495,800
Width, W	110,000
Height, H	16,200
A	22,000

MANUFACTURER

[SKF](#)