

PHG C248X3 SKF

Banded classical belt

TYPE: V- belts, Banded belts, Classical, Section 22/C (SKF)

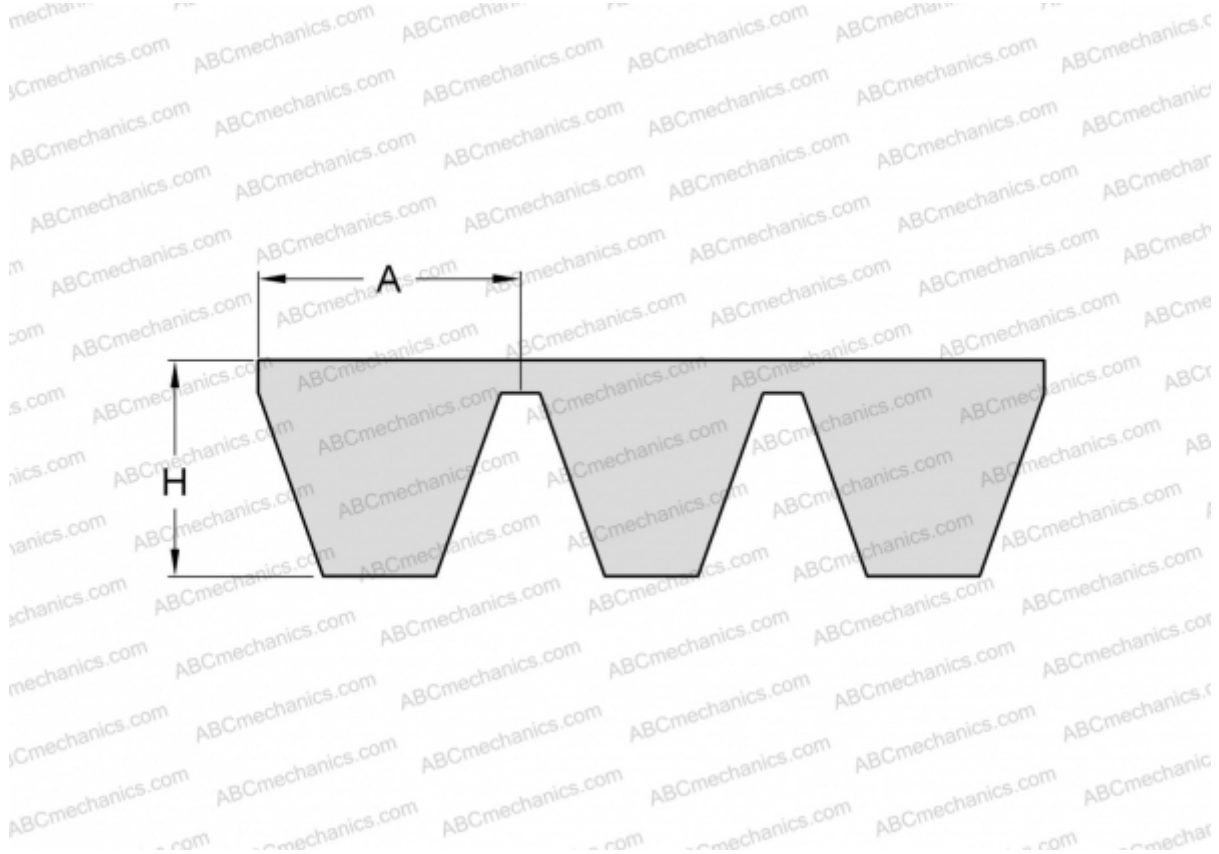

Technical specification

DIMENSIONS, MM

Estimated length	6360,000
Inner length	6299,200
Width, W	66,000
Height, H	16,200
A	22,000

MANUFACTURER

[SKF](#)