

PHG D162X3 SKF

Banded classical belt

TYPE: V- belts, Banded belts, Classical, Section 32/D (SKF)

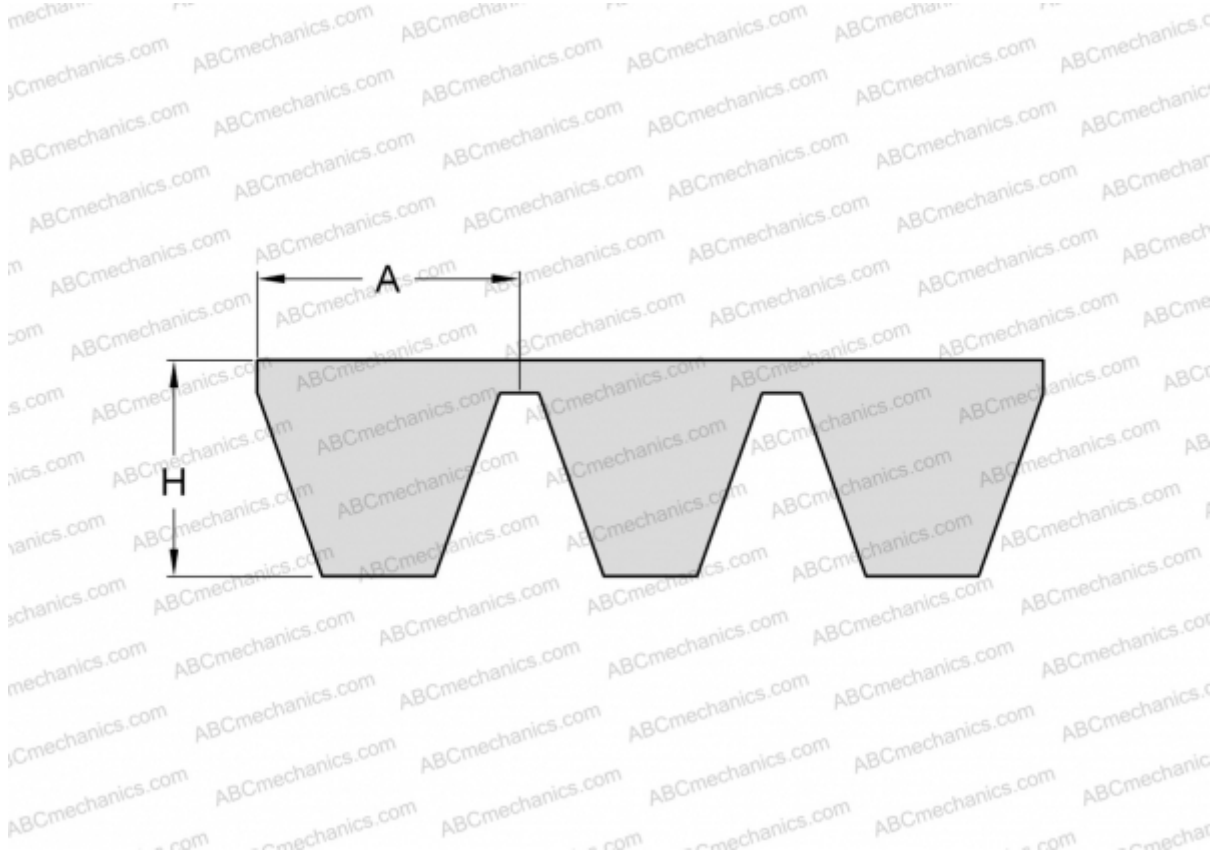

Technical specification

DIMENSIONS, MM

Estimated length	4190,000
Inner length	4114,800
Width, W	96,000
Height, H	22,400
A	32,000

MANUFACTURER

[SKF](#)