

PHG D180X5 SKF

Banded classical belt

TYPE: V- belts, Banded belts, Classical, Section 32/D (SKF)

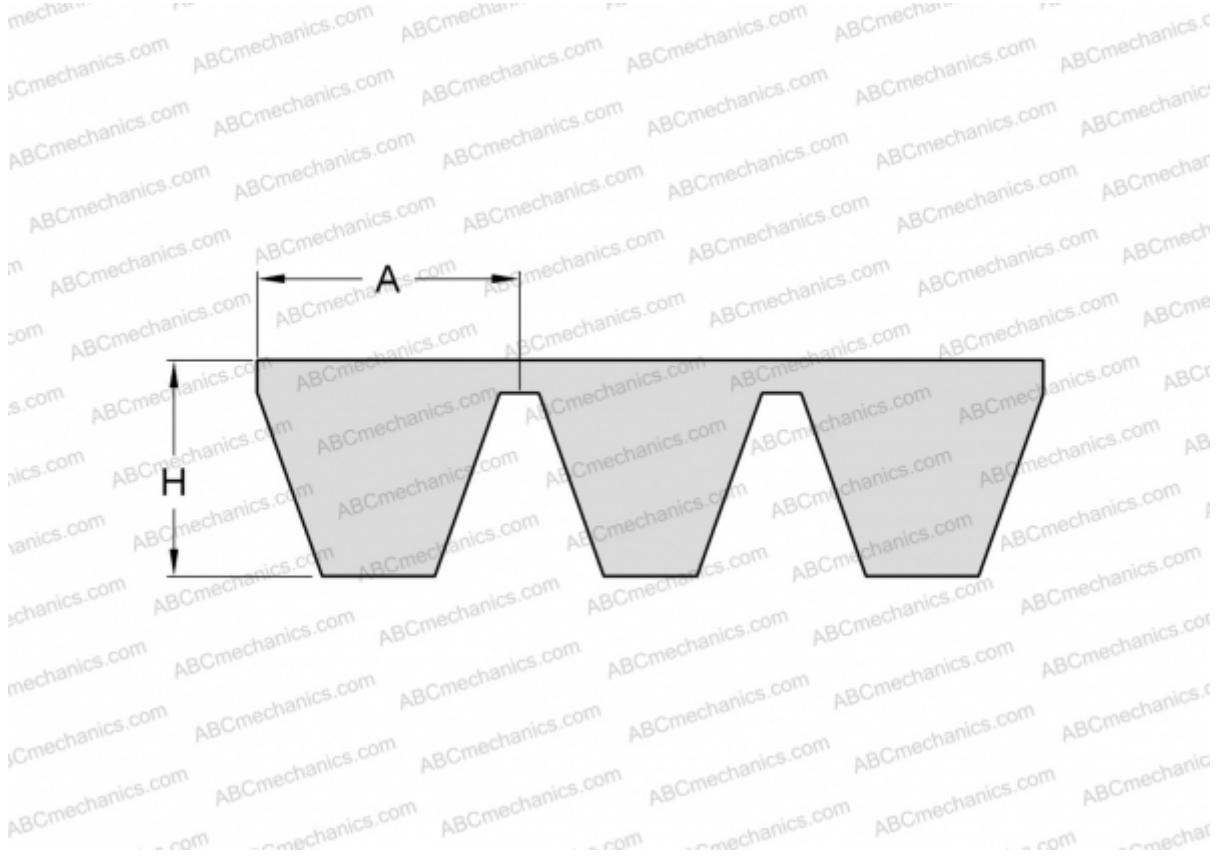

Technical specification

DIMENSIONS, MM

Estimated length	4650,000
Inner length	4572,000
Width, W	160,000
Height, H	22,400
A	32,000

MANUFACTURER

[SKF](#)