

PHG D255X4 SKF

Banded classical belt

TYPE: V- belts, Banded belts, Classical, Section 32/D (SKF)

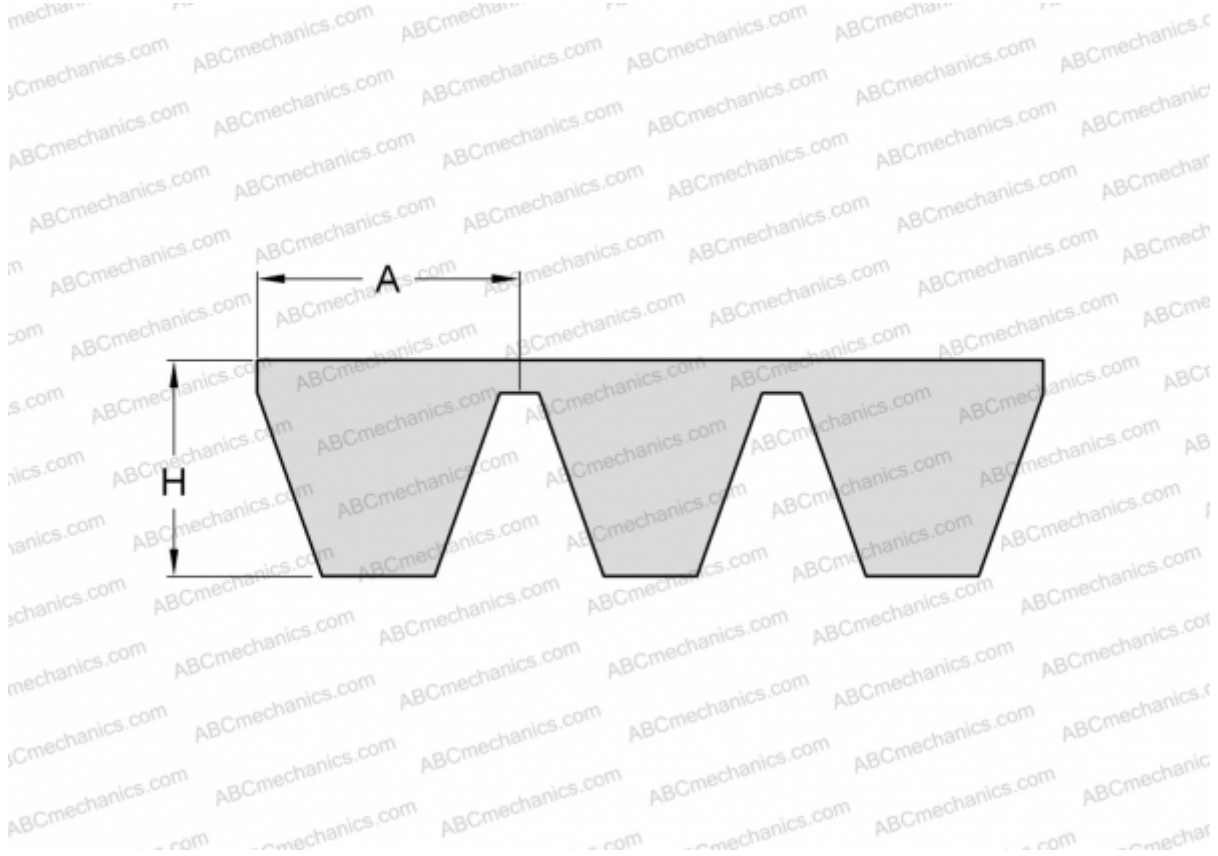

Technical specification

DIMENSIONS, MM

Estimated length	6560,000
Inner length	6477,000
Width, W	128,000
Height, H	22,400
A	32,000

MANUFACTURER

[SKF](#)