

## PHG D315X3 SKF

Banded classical belt

TYPE: V- belts, Banded belts, Classical, Section 32/D (SKF)

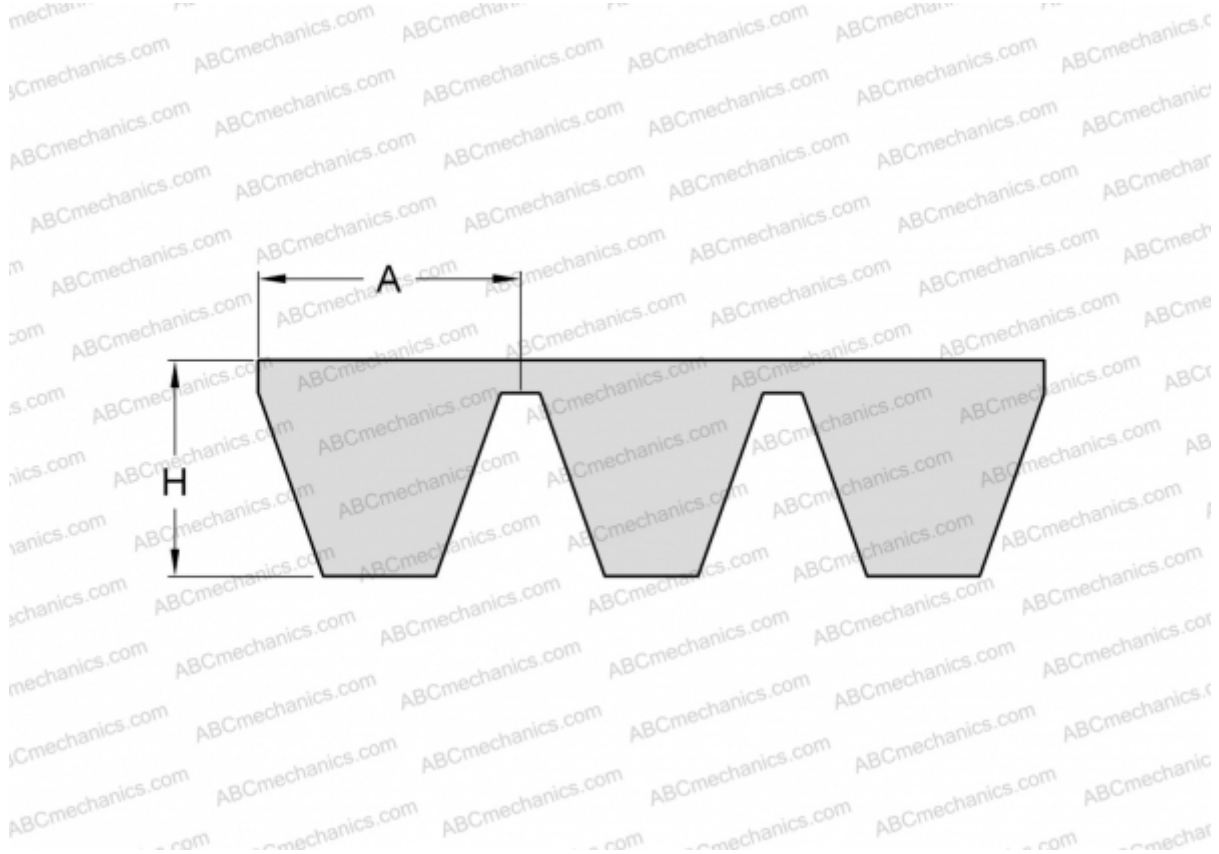

### Technical specification

#### DIMENSIONS, MM

Estimated length	8080,000
Inner length	8001,000
Width, W	96,000
Height, H	22,400
A	32,000

#### MANUFACTURER

[SKF](#)