

PHG D360X5 SKF

Banded classical belt

TYPE: V- belts, Banded belts, Classical, Section 32/D (SKF)

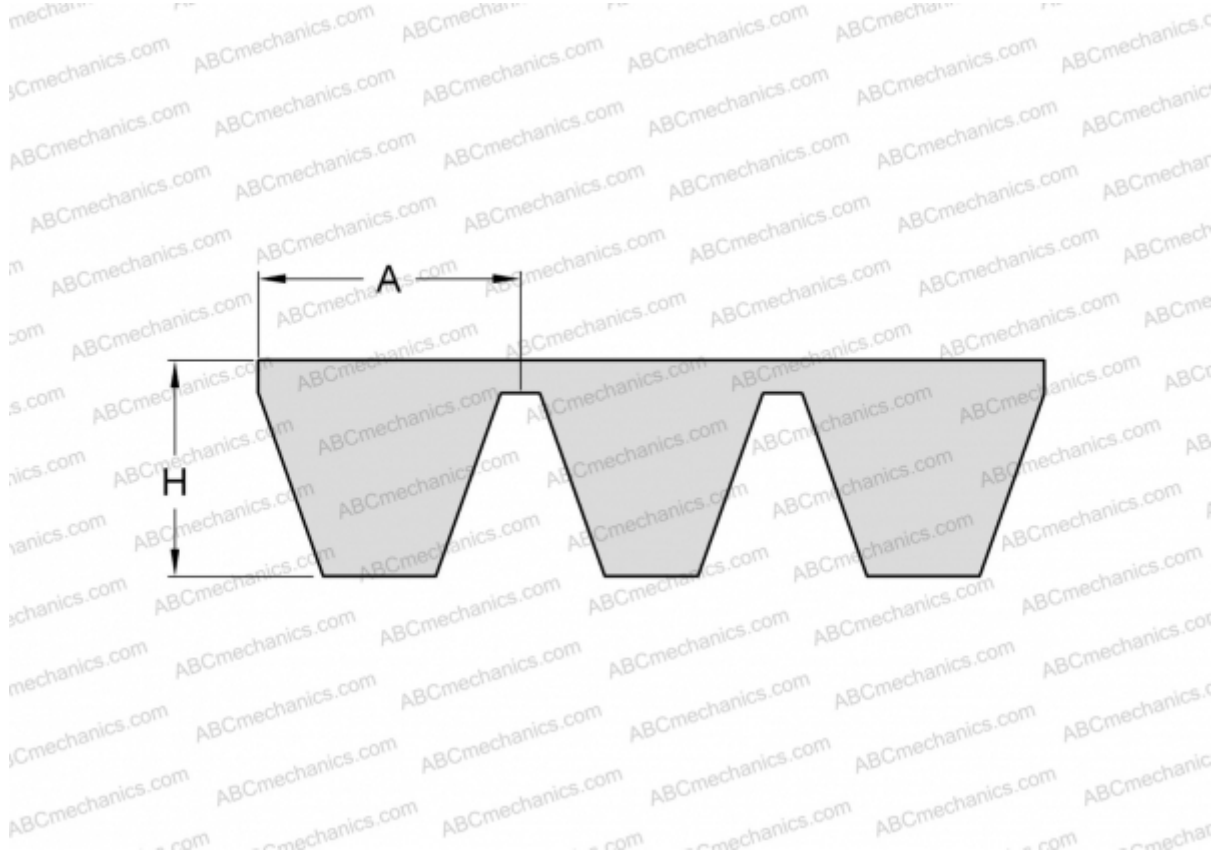

Technical specification

DIMENSIONS, MM

Estimated length	9220,000
Inner length	9144,000
Width, W	160,000
Height, H	22,400
A	32,000

MANUFACTURER

[SKF](#)