

PHG D390X3 SKF

Banded classical belt

TYPE: V- belts, Banded belts, Classical, Section 32/D (SKF)

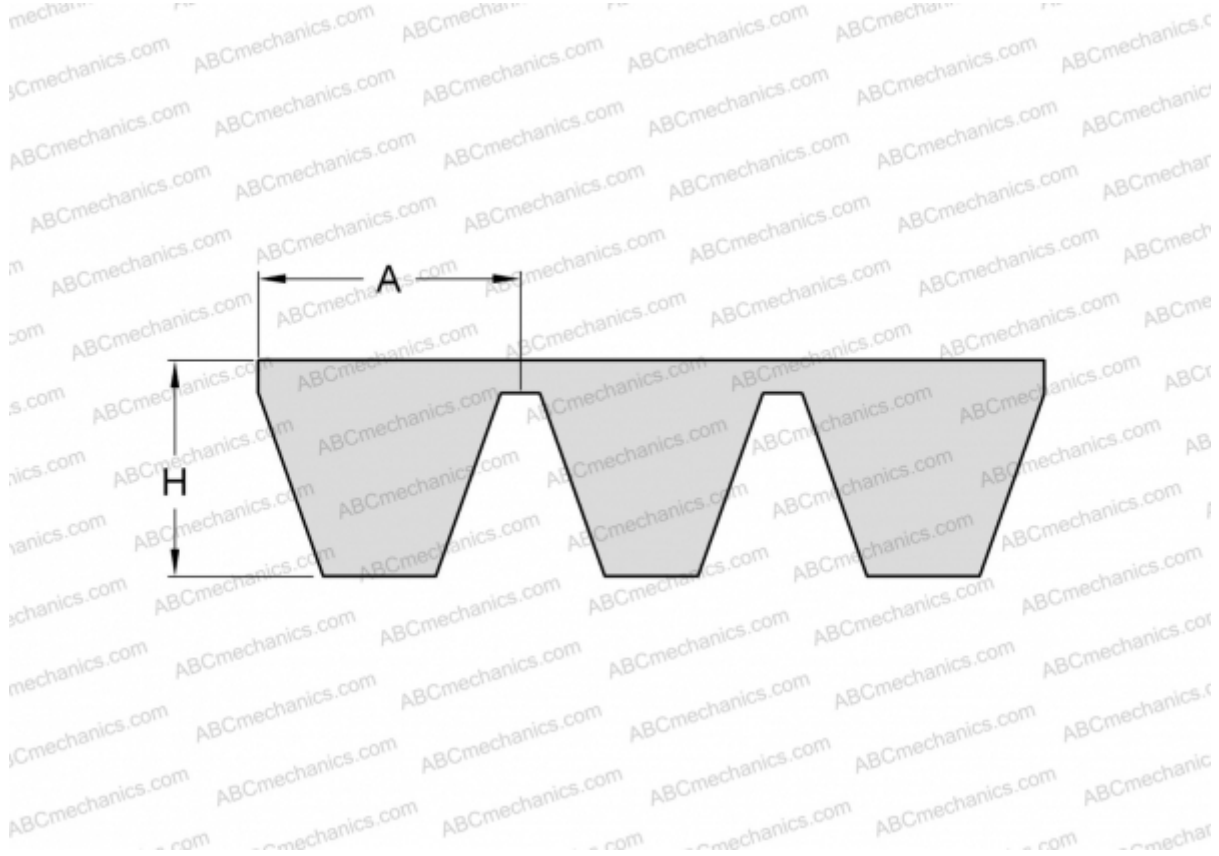

Technical specification

DIMENSIONS, MM

Estimated length	9980,000
Inner length	9906,000
Width, W	96,000
Height, H	22,400
A	32,000

MANUFACTURER

[SKF](#)