

## PHG SPA1600X5 SKF

Banded wedge belt

TYPE: V- belts, Banded belts, Standart ANSI (USA), Section SPA (SKF)

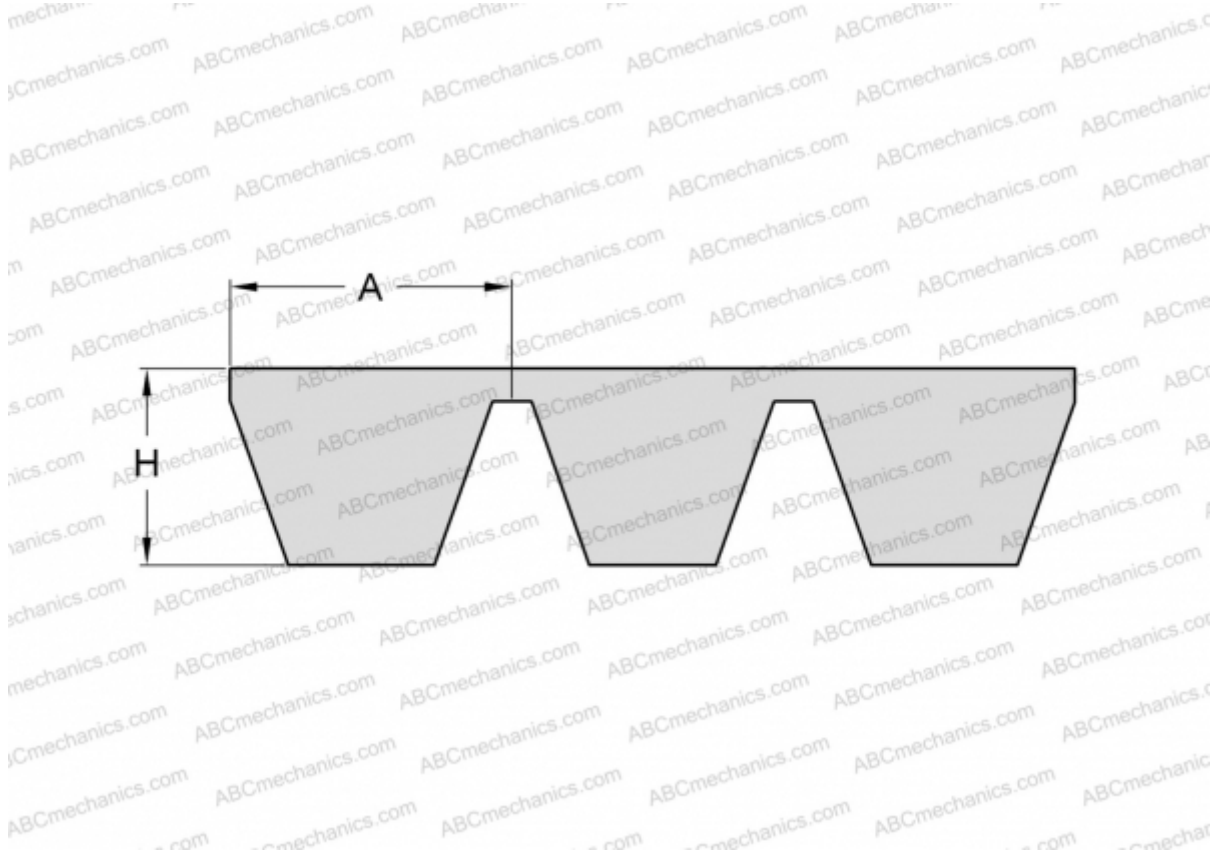

### Technical specification

#### DIMENSIONS, MM

Estimated length	1600,000
Width, W	64,000
Height, H	12,000
A	12,800

#### MANUFACTURER

[SKF](#)