

## PHG SPA1900X4 SKF

Banded wedge belt

TYPE: V- belts, Banded belts, Standart ANSI (USA), Section SPA (SKF)

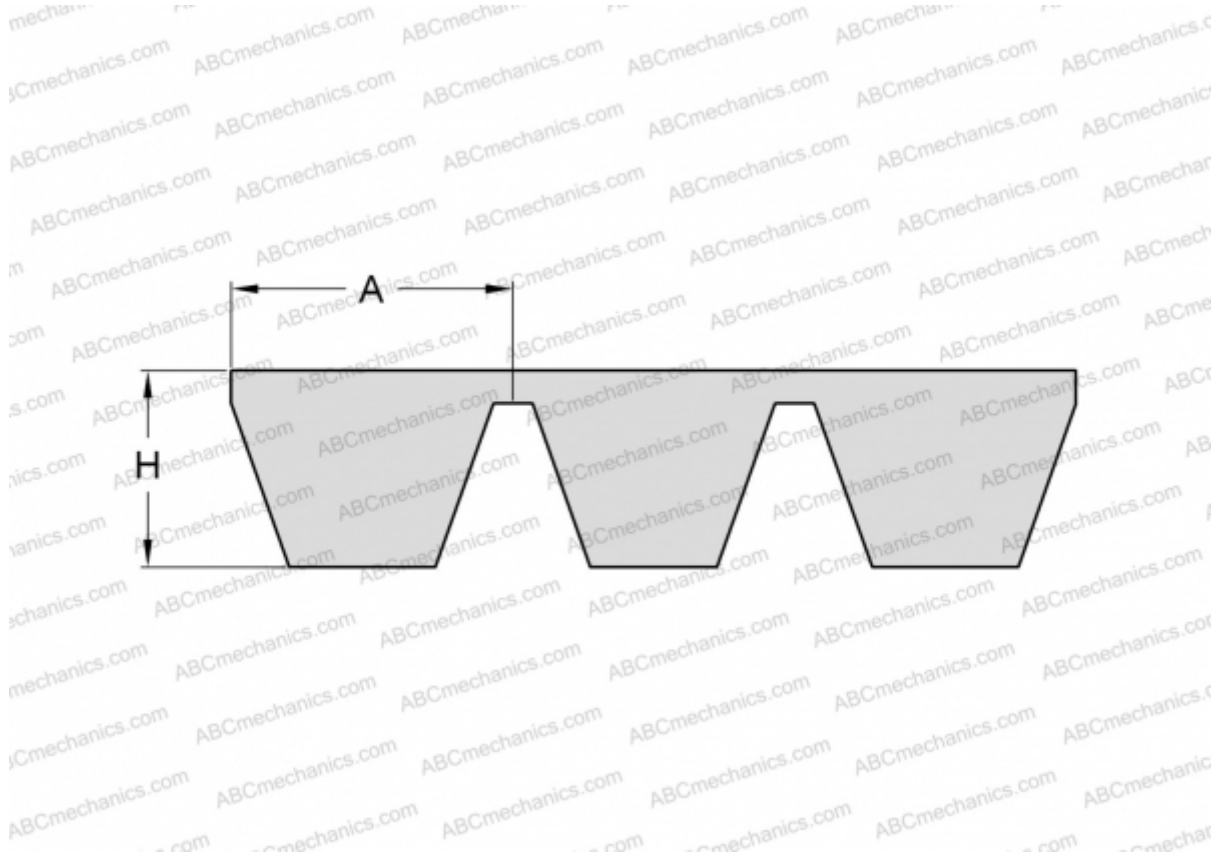

### Technical specification

#### DIMENSIONS, MM

Estimated length	1900,000
Width, W	51,200
Height, H	12,000
A	12,800

#### MANUFACTURER

[SKF](#)