

## PHG SPA3550X4 SKF

Banded wedge belt

TYPE: V- belts, Banded belts, Standart ANSI (USA), Section SPA (SKF)

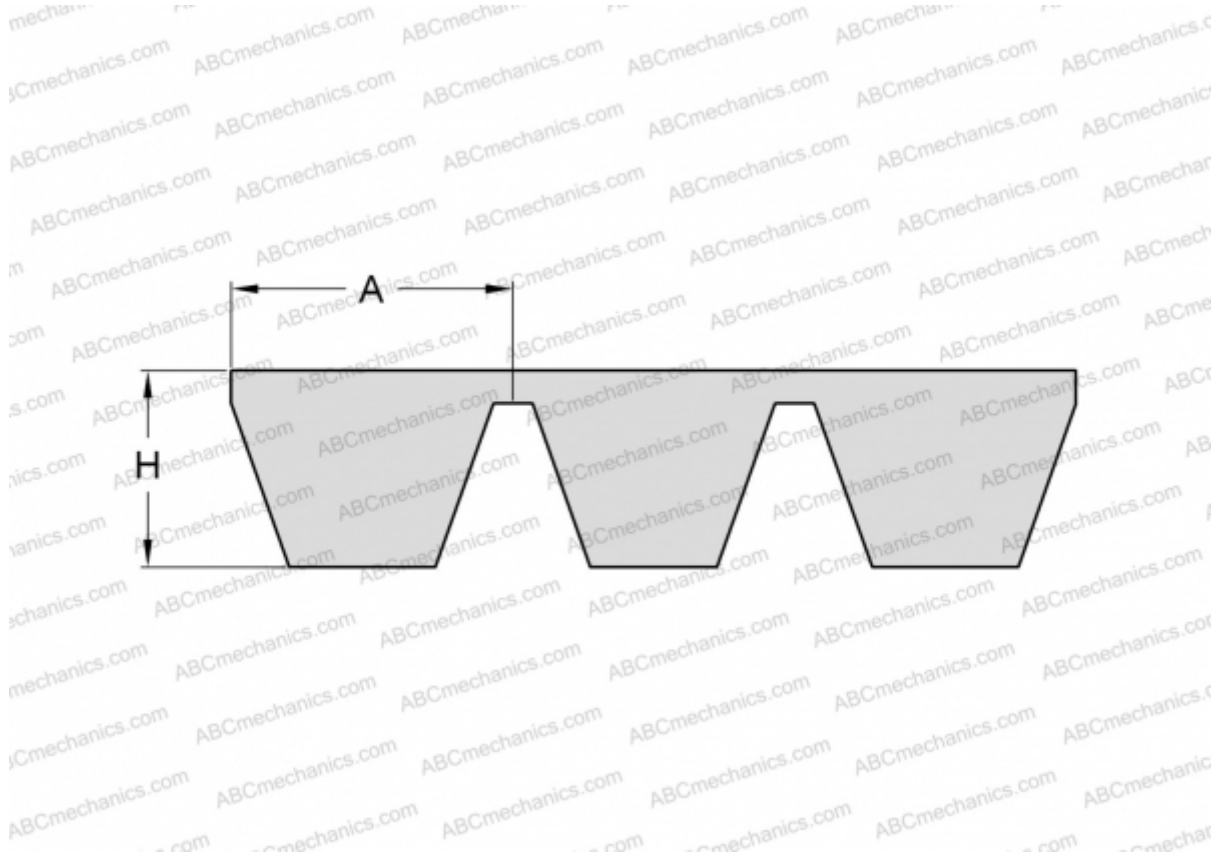

### Technical specification

#### DIMENSIONS, MM

|                  |          |
|------------------|----------|
| Estimated length | 3550,000 |
| Width, W         | 51,200   |
| Height, H        | 12,000   |
| A                | 12,800   |

#### MANUFACTURER

[SKF](#)