

PHG SPA3750X5 SKF

Banded wedge belt

TYPE: V- belts, Banded belts, Standart ANSI (USA), Section SPA (SKF)

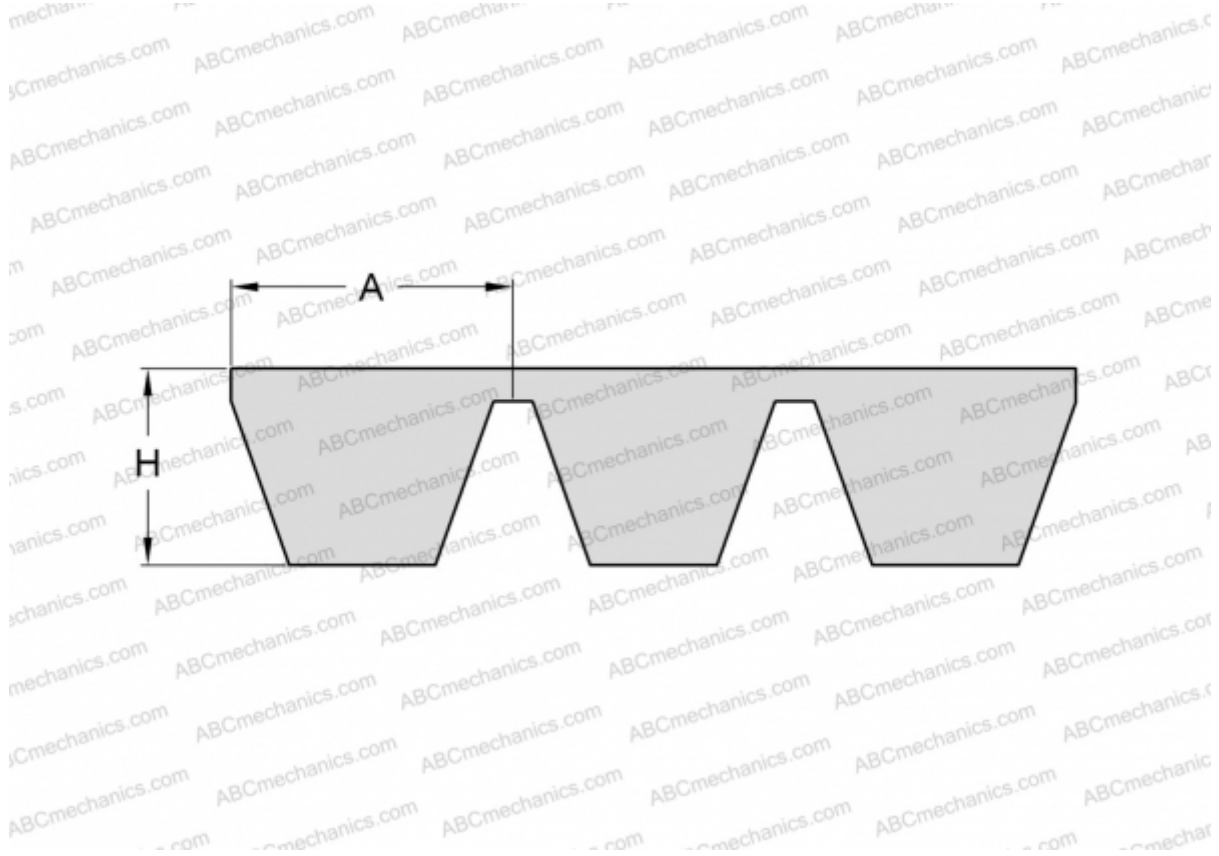

Technical specification

DIMENSIONS, MM

Estimated length	3750,000
Width, W	64,000
Height, H	12,000
A	12,800

MANUFACTURER

[SKF](#)