

PHG SPA4250X3 SKF

Banded wedge belt

TYPE: V- belts, Banded belts, Standart ANSI (USA), Section SPA (SKF)

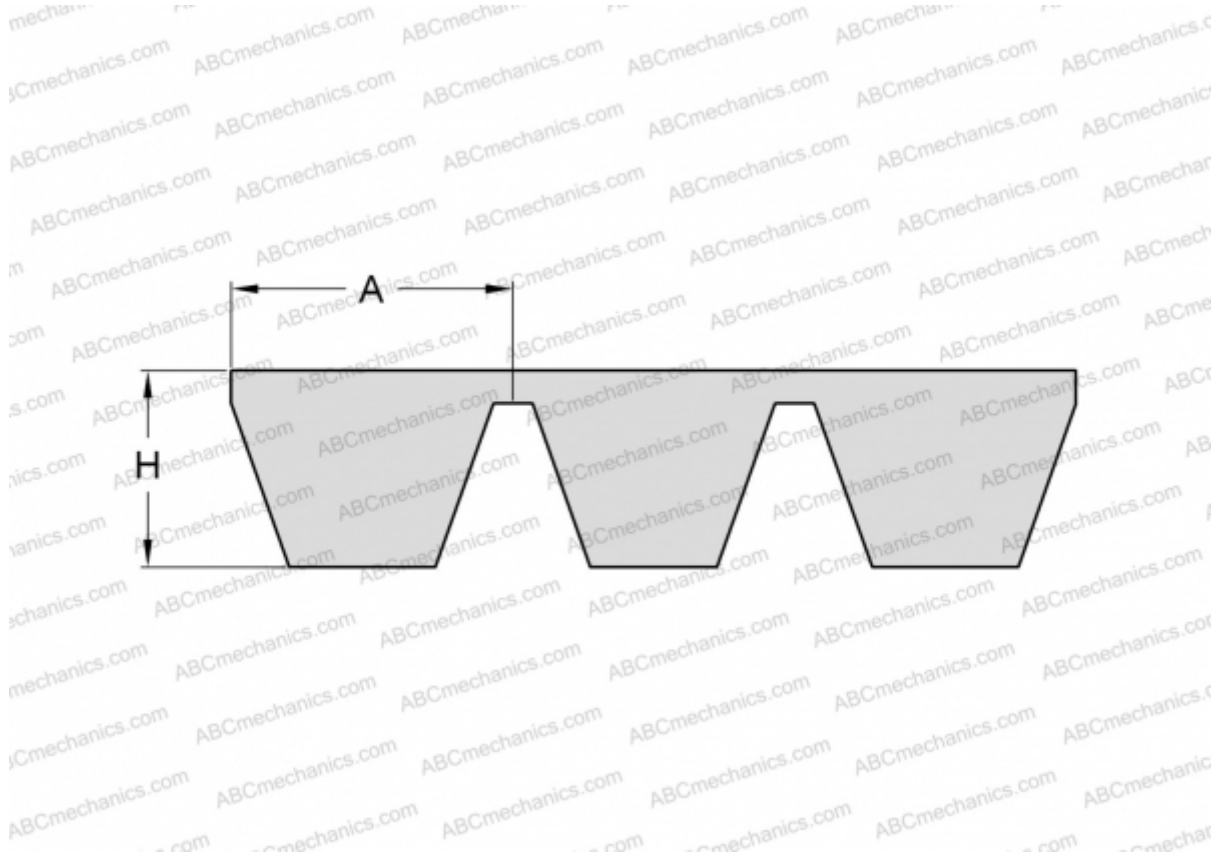

Technical specification

DIMENSIONS, MM

| | |
|------------------|----------|
| Estimated length | 4250,000 |
| Width, W | 38,400 |
| Height, H | 12,000 |
| A | 12,800 |

MANUFACTURER

[SKF](#)