

PHG SPA4500X4 SKF

Banded wedge belt

TYPE: V- belts, Banded belts, Standart ANSI (USA), Section SPA (SKF)

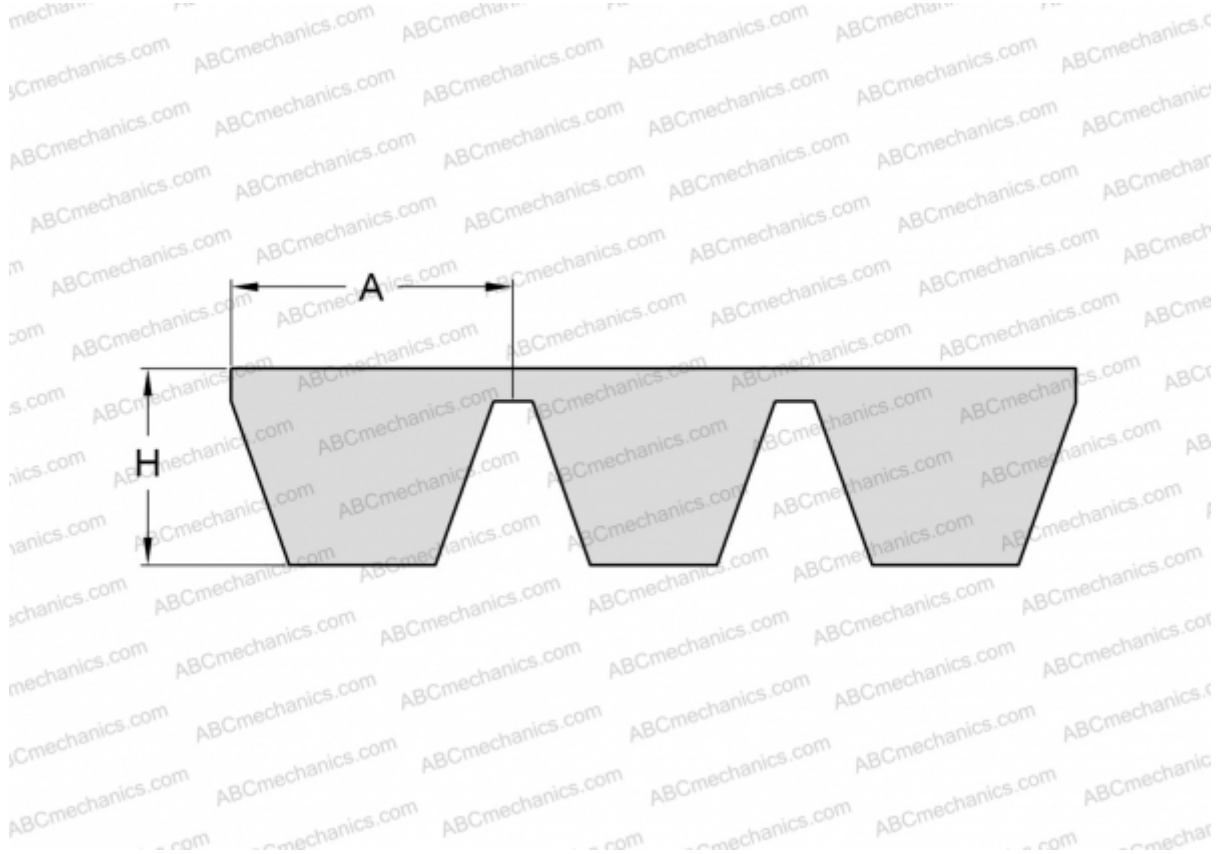

Technical specification

DIMENSIONS, MM

Estimated length	4500,000
Width, W	51,200
Height, H	12,000
A	12,800

MANUFACTURER

[SKF](#)