

## PHG SPB3350X5 SKF

Banded wedge belt

TYPE: V- belts, Banded belts, Standart ANSI (USA), Section SPB (SKF)

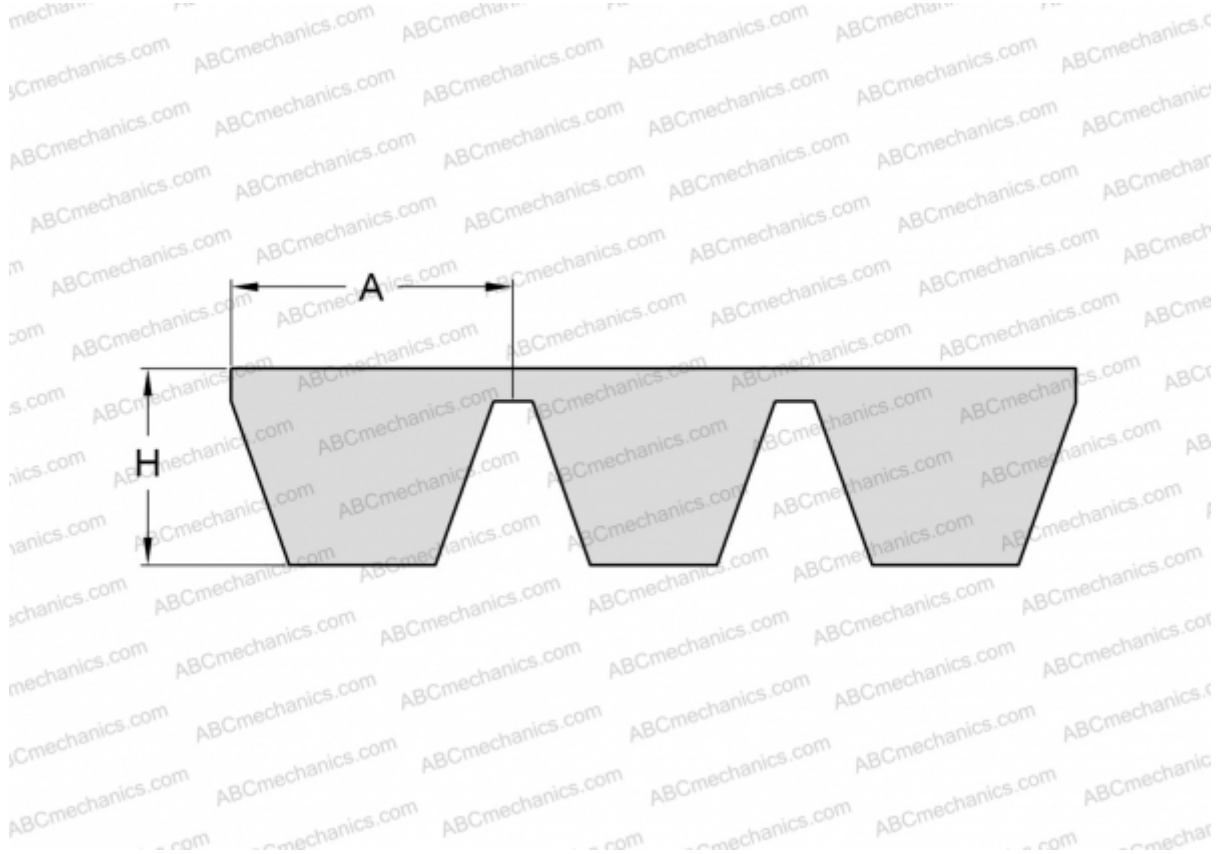

### Technical specification

#### DIMENSIONS, MM

Estimated length	3350,000
Width, W	82,500
Height, H	15,600
A	16,500

#### MANUFACTURER

[SKF](#)