

PHG SPB3550X3 SKF

Banded wedge belt

TYPE: V- belts, Banded belts, Standart ANSI (USA), Section SPB (SKF)

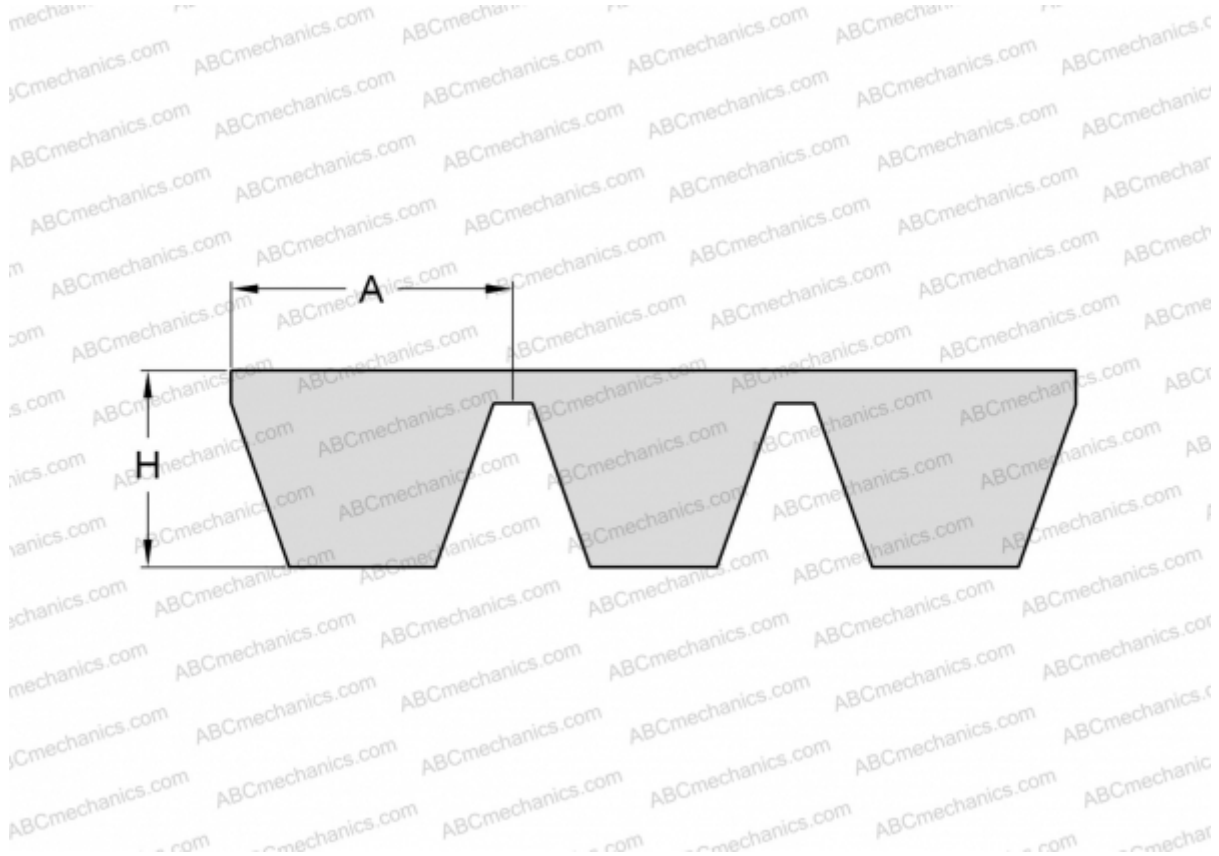

Technical specification

DIMENSIONS, MM

Estimated length	3550,000
Width, W	49,500
Height, H	15,600
A	16,500

MANUFACTURER

[SKF](#)