

PHG SPB5300X5 SKF

Banded wedge belt

TYPE: V- belts, Banded belts, Standart ANSI (USA), Section SPB (SKF)

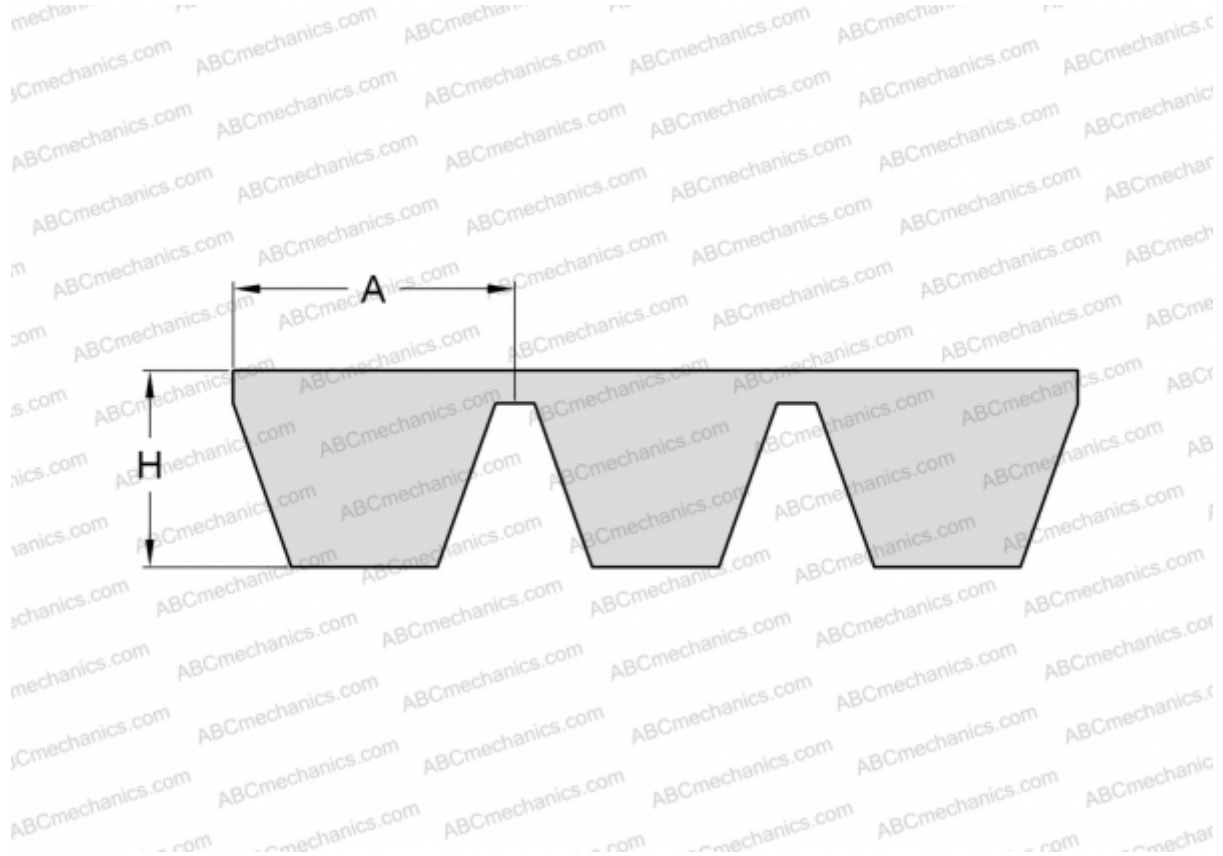

Technical specification

DIMENSIONS, MM

| | |
|------------------|----------|
| Estimated length | 5300,000 |
| Width, W | 82,500 |
| Height, H | 15,600 |
| A | 16,500 |

MANUFACTURER

[SKF](#)