

PHG SPC4500X5 SKF

Banded wedge belt

TYPE: V- belts, Banded belts, Standart ANSI (USA), Section SPC (SKF)

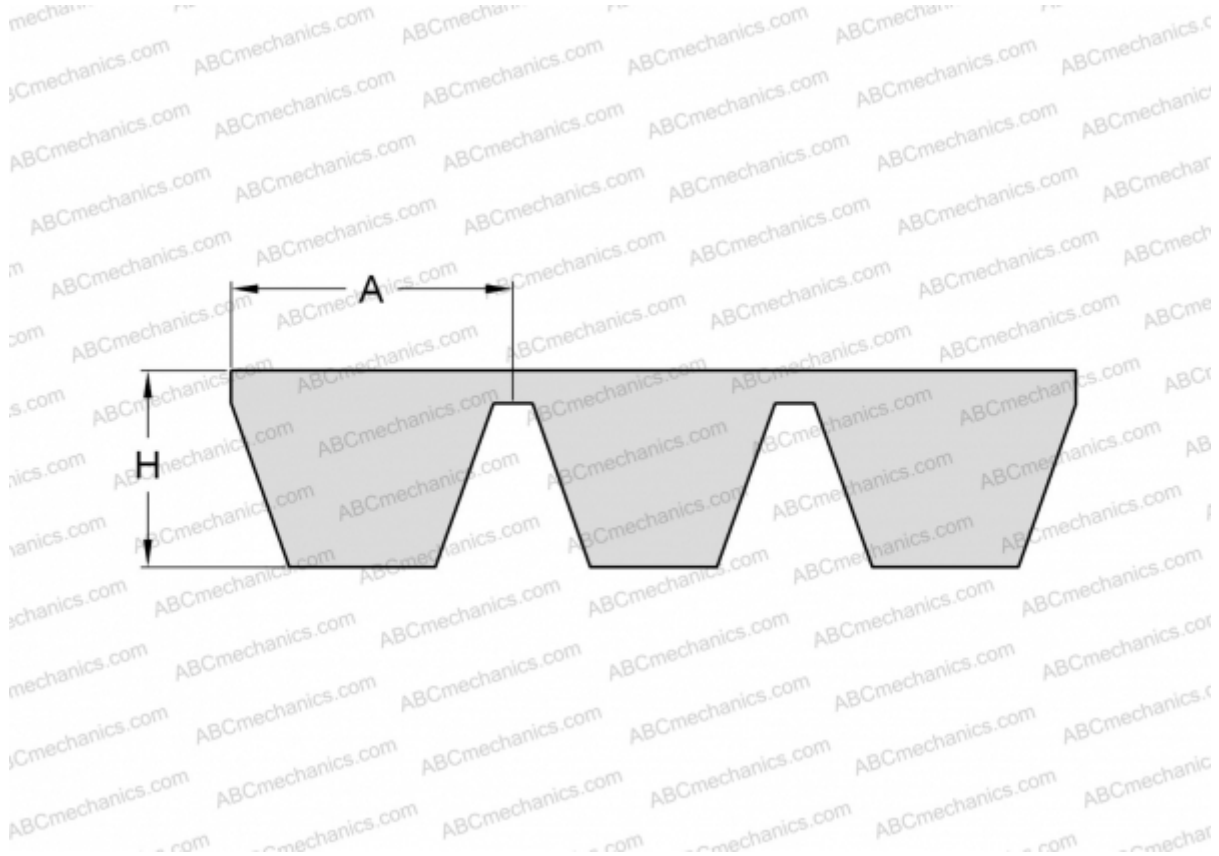

Technical specification

DIMENSIONS, MM

| | |
|------------------|----------|
| Estimated length | 4500,000 |
| Width, W | 110,000 |
| Height, H | 22,600 |
| A | 22,000 |

MANUFACTURER

[SKF](#)