

PHG SPC7500X4 SKF

Banded wedge belt

TYPE: V- belts, Banded belts, Standart ANSI (USA), Section SPC (SKF)

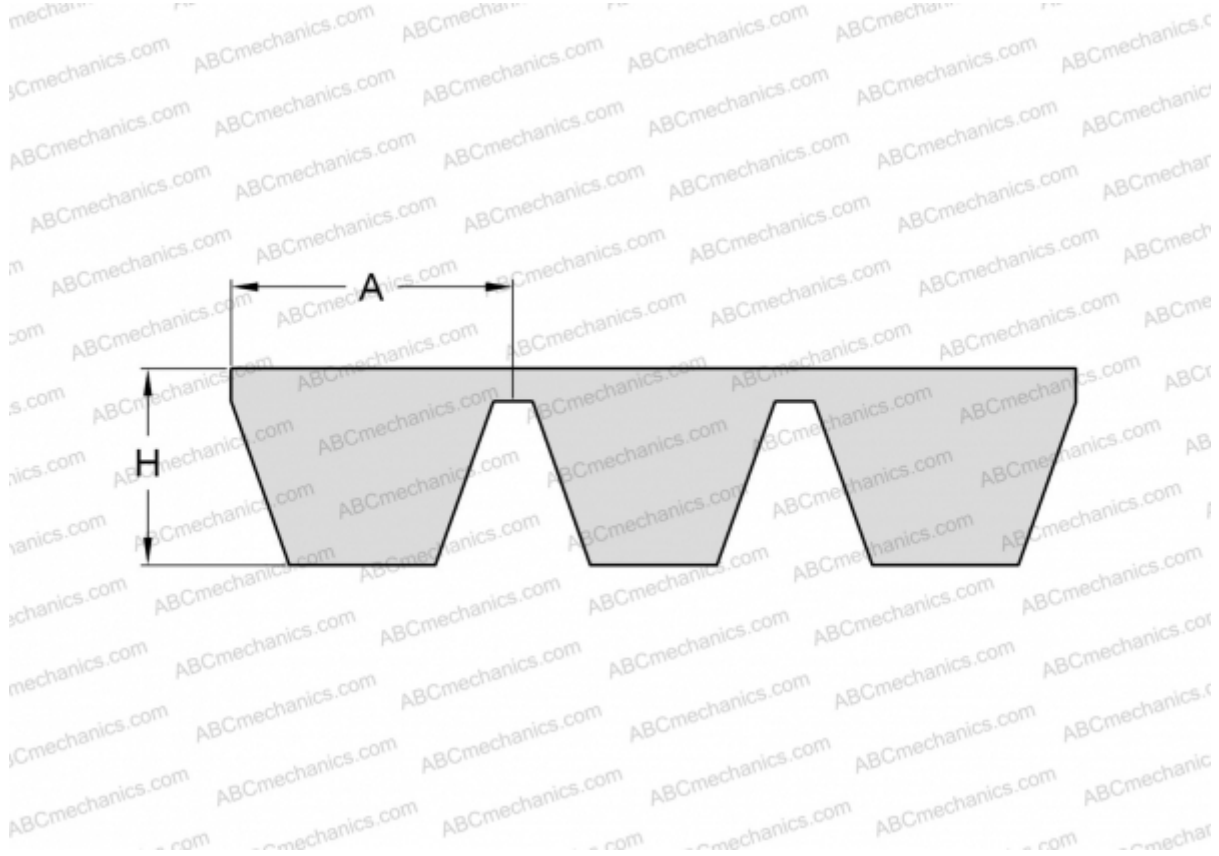

Technical specification

DIMENSIONS, MM

Estimated length	7500,000
Width, W	88,000
Height, H	22,600
A	22,000

MANUFACTURER

[SKF](#)