

## PHG 3V630X5 SKF

Banded narrow wedge belt

TYPE: V- belts, Banded belts, Narrow standart ANSI (USA), Section 3V/9J (SKF)

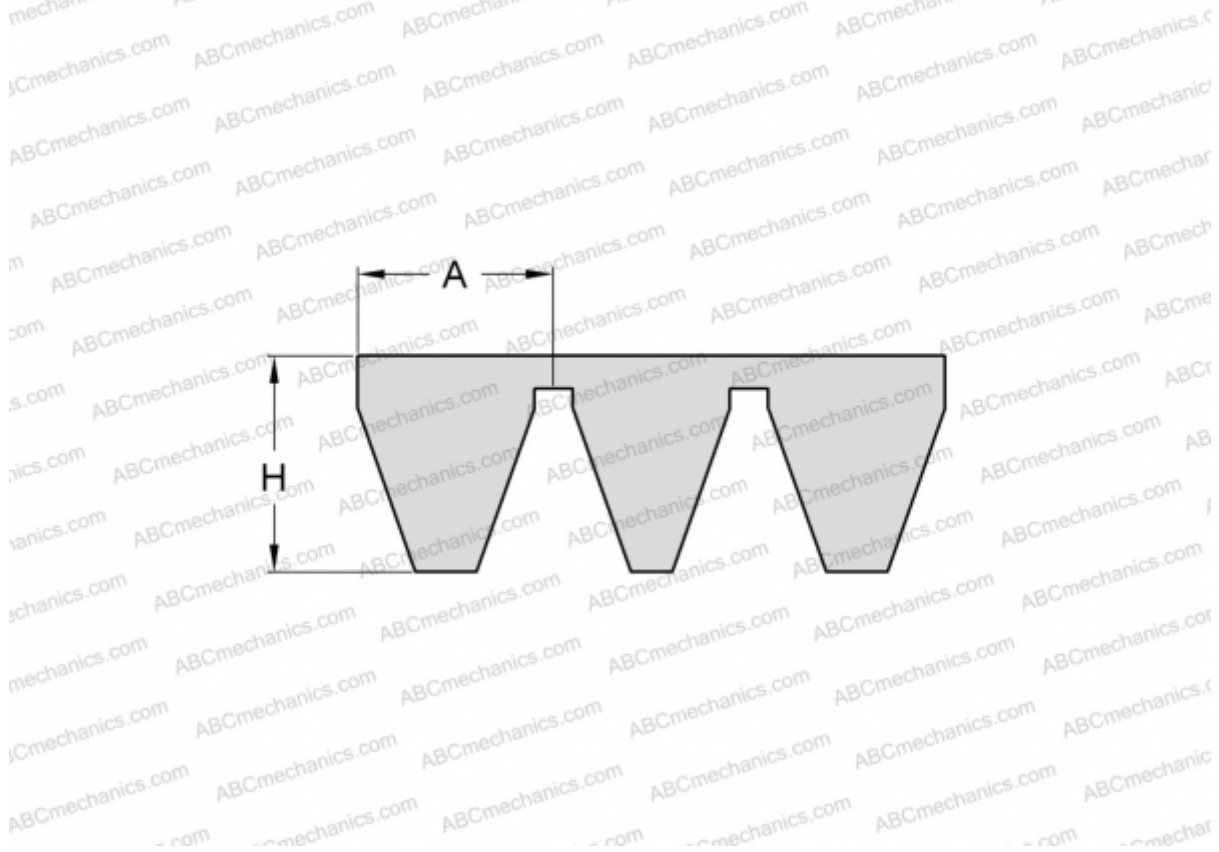

### Technical specification

#### DIMENSIONS, MM

Estimated length	1600,000
Width, W	45,000
Height, H	9,900
A	9,000

#### MANUFACTURER

[SKF](#)