

PHG 3V800X4 SKF

Banded narrow wedge belt

TYPE: V- belts, Banded belts, Narrow standart ANSI (USA), Section 3V/9J (SKF)

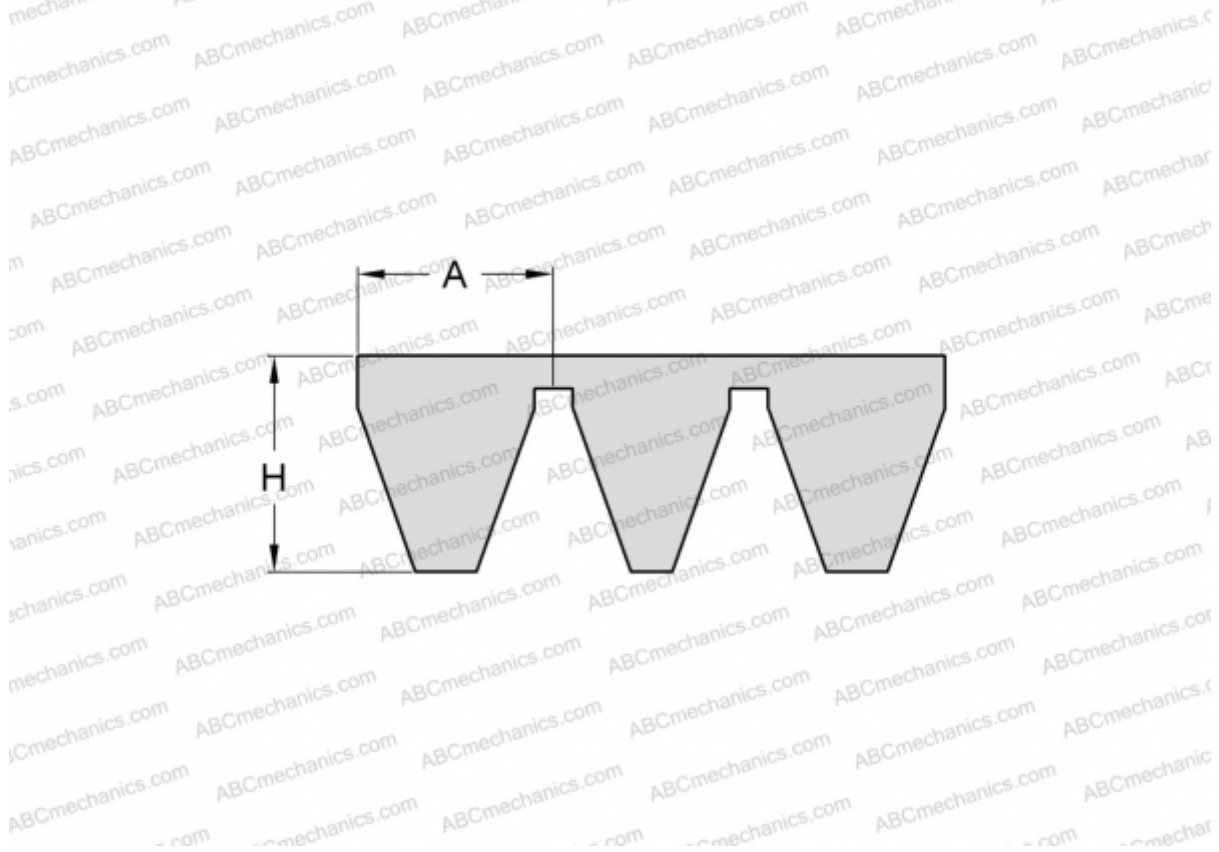

Technical specification

DIMENSIONS, MM

Estimated length	2032,000
Width, W	36,000
Height, H	9,900
A	9,000

MANUFACTURER

[SKF](#)