

PHG 3V950X5 SKF

Banded narrow wedge belt

TYPE: V- belts, Banded belts, Narrow standart ANSI (USA), Section 3V/9J (SKF)

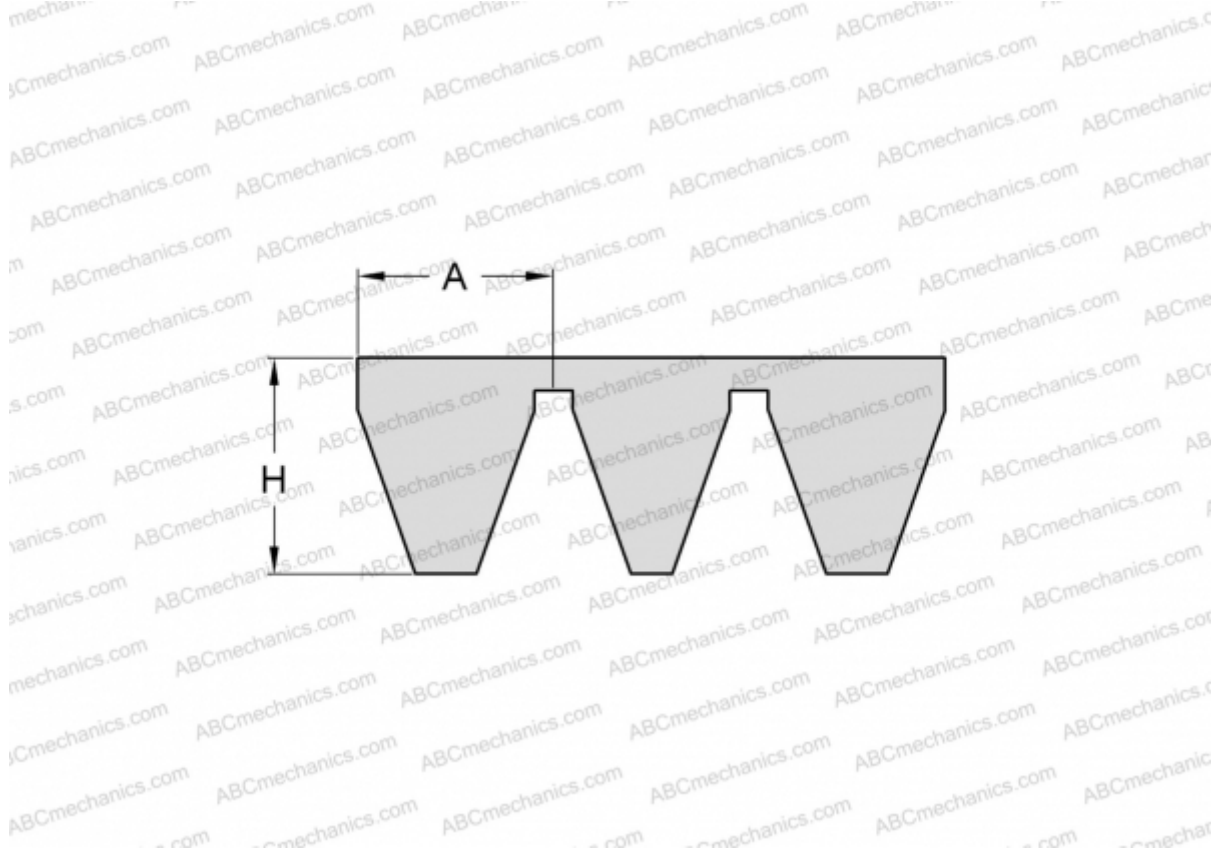

Technical specification

DIMENSIONS, MM

Estimated length	2413,000
Width, W	45,000
Height, H	9,900
A	9,000

MANUFACTURER

[SKF](#)