

## PHG 5V670X5 SKF

Banded narrow wedge belt

TYPE: V- belts, Banded belts, Narrow standart ANSI (USA), Section 5V/15J (SKF)

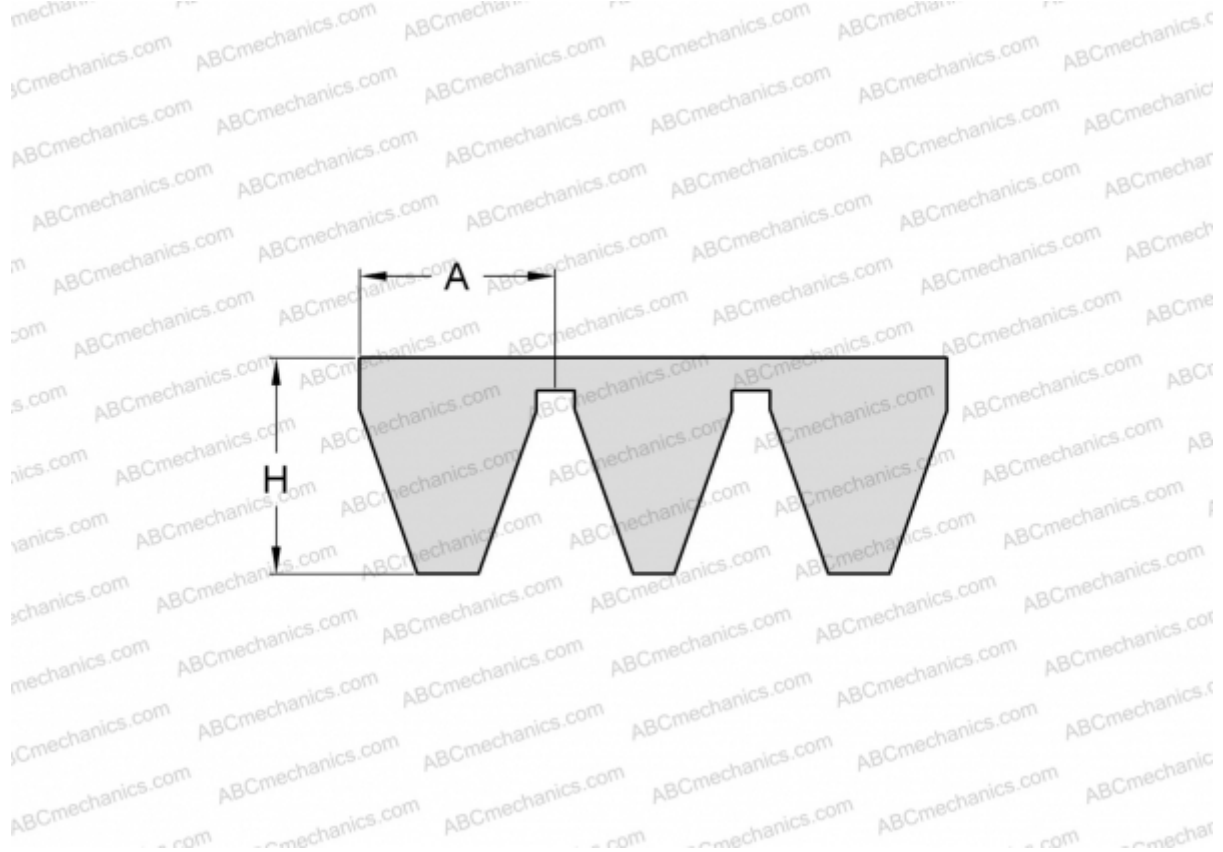

### Technical specification

#### DIMENSIONS, MM

|                  |          |
|------------------|----------|
| Estimated length | 1702,000 |
| Width, W         | 75,000   |
| Height, H        | 15,100   |
| A                | 15,000   |

#### MANUFACTURER

[SKF](#)