

PHG 5V850X5 SKF

Banded narrow wedge belt

TYPE: V- belts, Banded belts, Narrow standart ANSI (USA), Section 5V/15J (SKF)

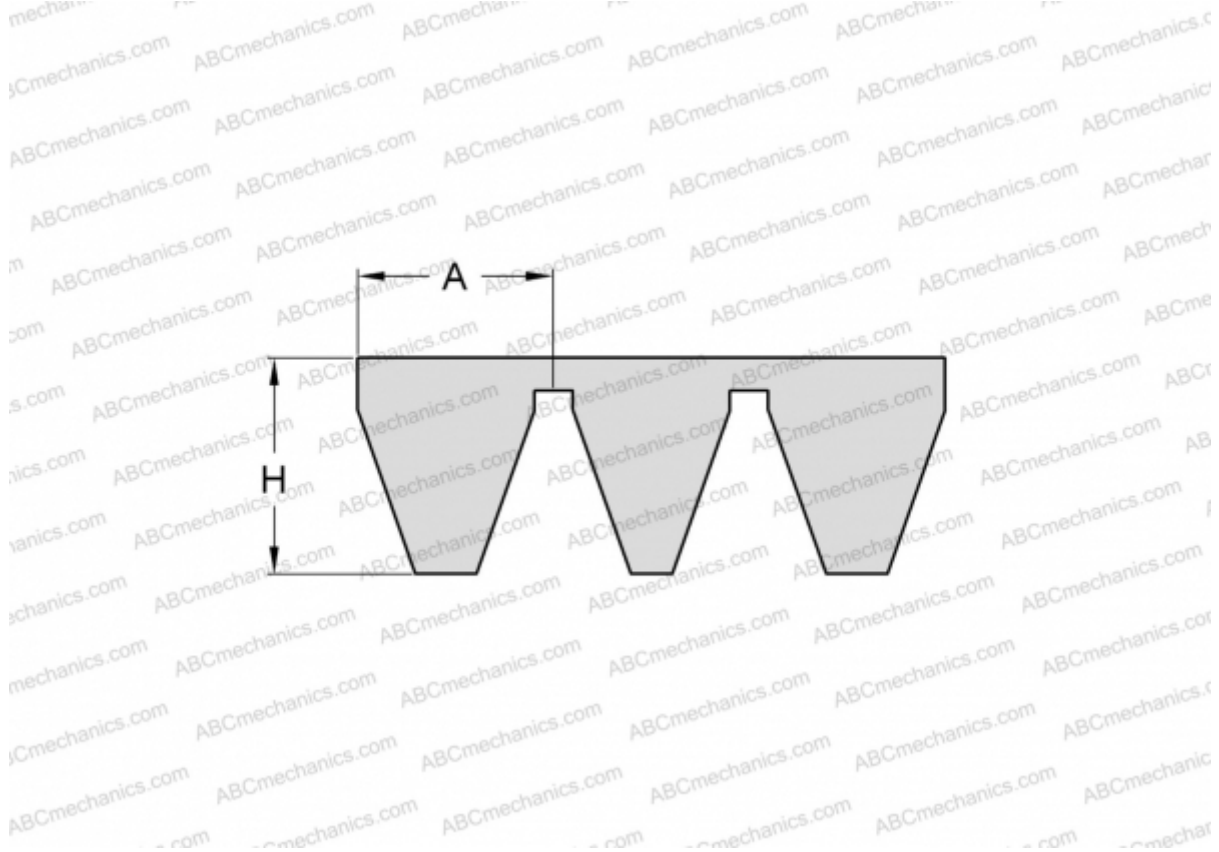

Technical specification

DIMENSIONS, MM

| | |
|------------------|----------|
| Estimated length | 2159,000 |
| Width, W | 75,000 |
| Height, H | 15,100 |
| A | 15,000 |

MANUFACTURER

[SKF](#)