

PHG 5V2500X4 SKF

Banded narrow wedge belt

TYPE: V- belts, Banded belts, Narrow standart ANSI (USA), Section 5V/15J (SKF)

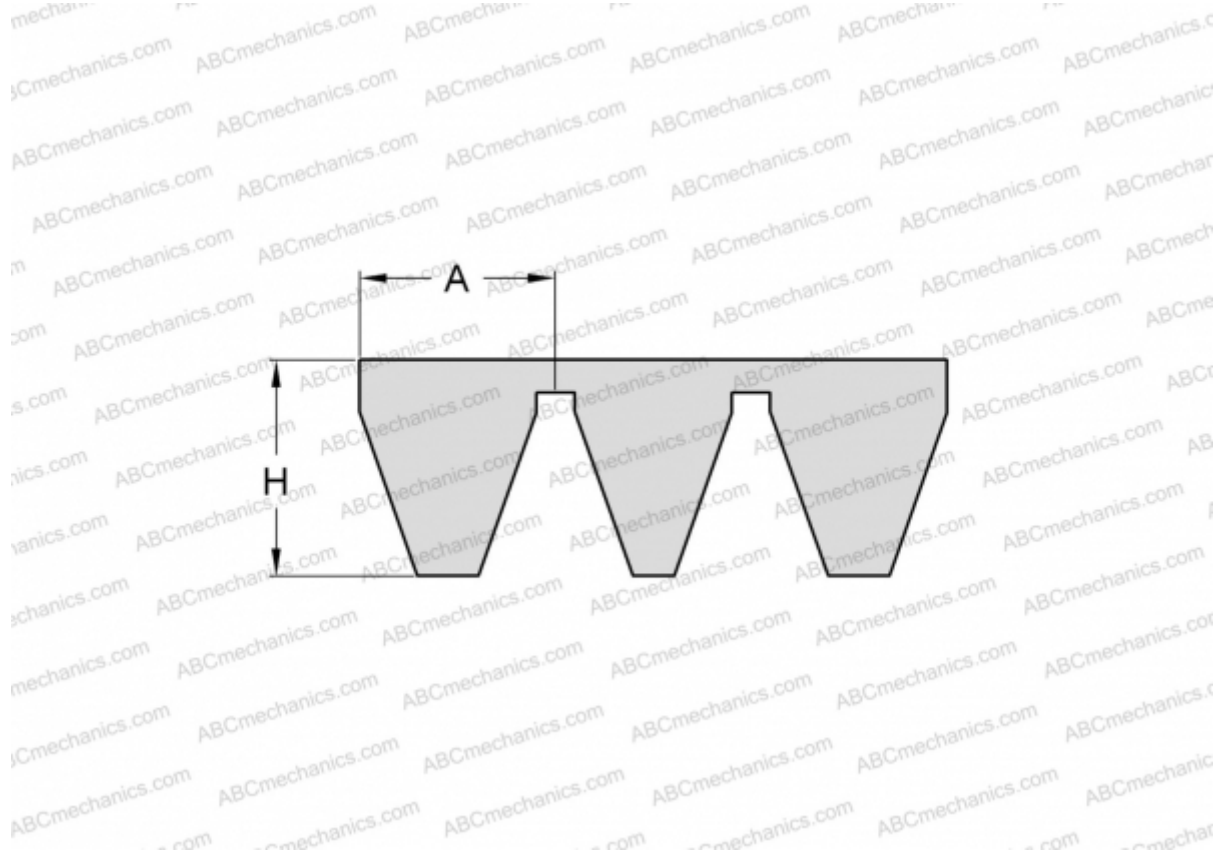

Technical specification

DIMENSIONS, MM

Estimated length	6350,000
Width, W	60,000
Height, H	15,100
A	15,000

MANUFACTURER

[SKF](#)