

PHG 8V1800X5 SKF

Banded narrow wedge belt

TYPE: V- belts, Banded belts, Narrow standart ANSI (USA), Section 8V/25J (SKF)

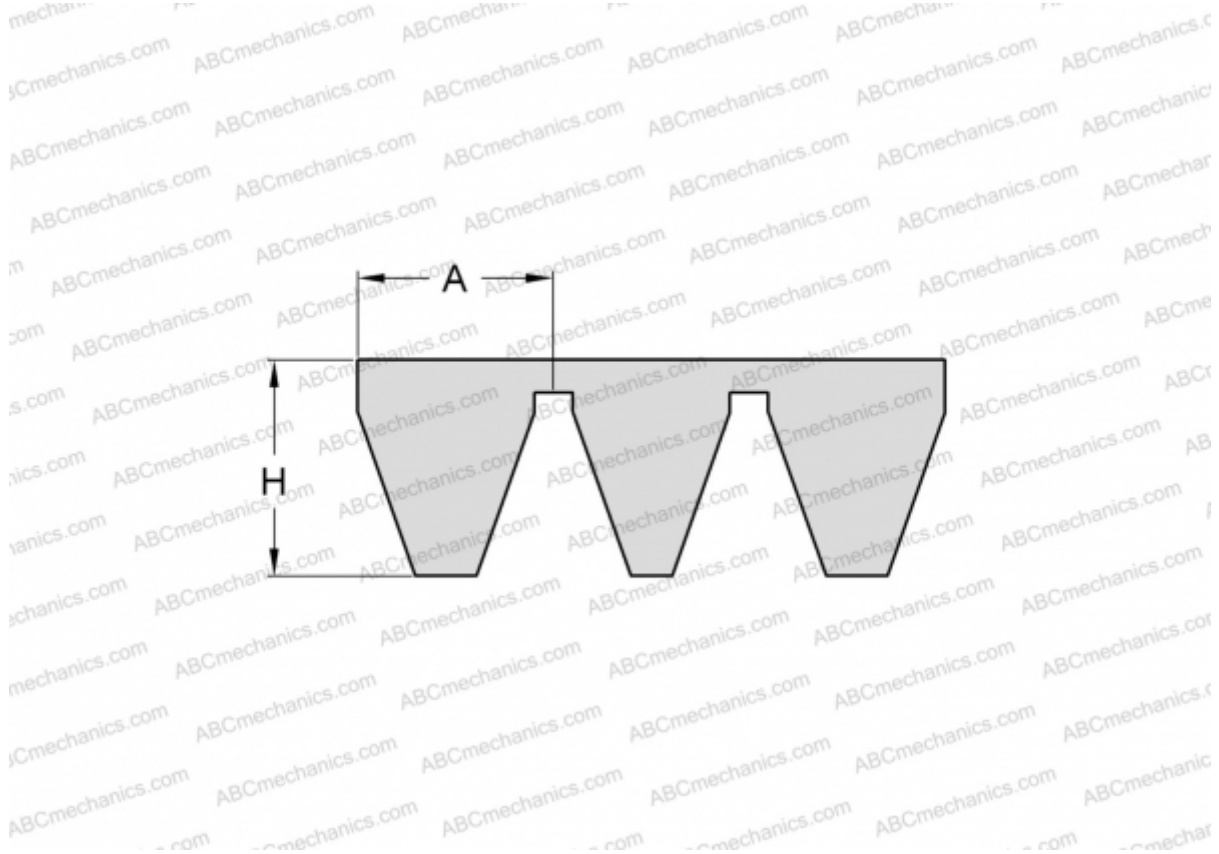

Technical specification

DIMENSIONS, MM

Estimated length	4572,000
Width, W	125,000
Height, H	25,500
A	25,000

MANUFACTURER

[SKF](#)