

PHG 8V2000X5 SKF

Banded narrow wedge belt

TYPE: V- belts, Banded belts, Narrow standart ANSI (USA), Section 8V/25J (SKF)

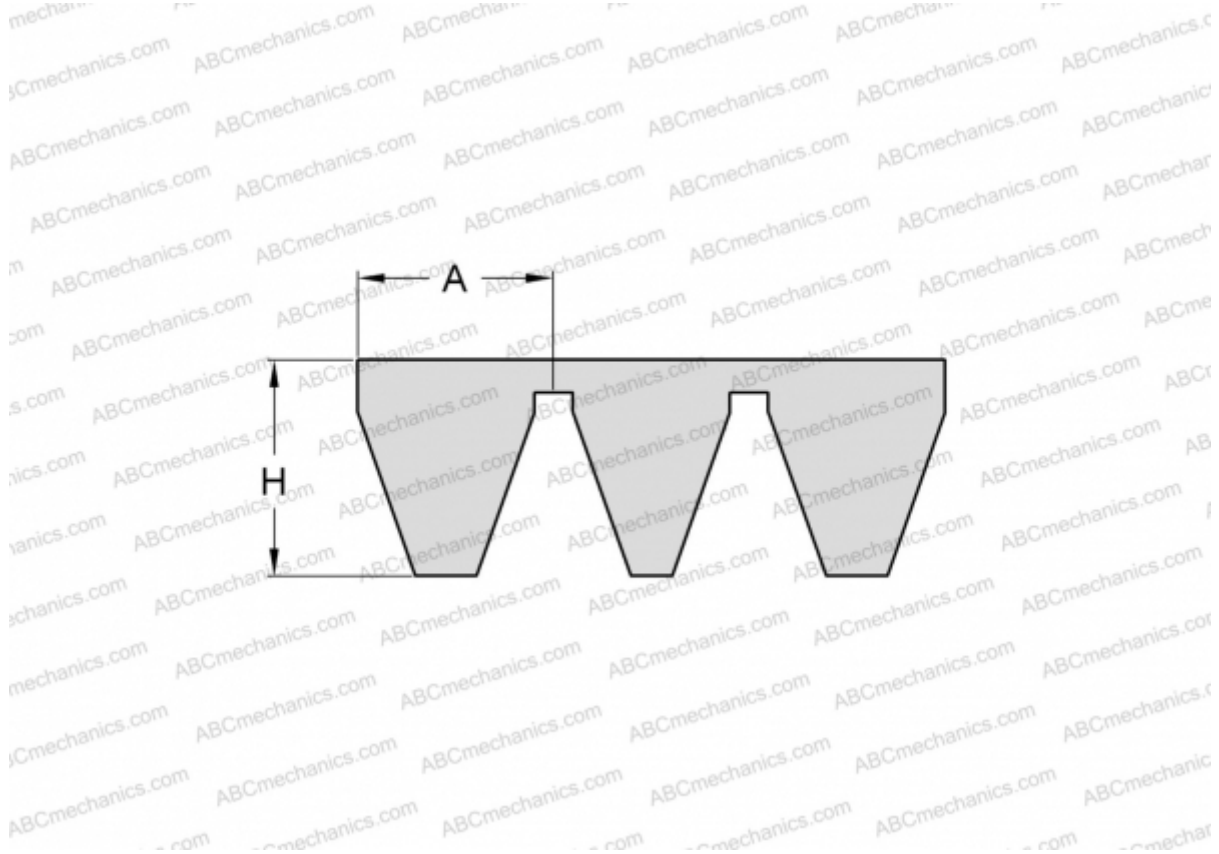

Technical specification

DIMENSIONS, MM

| | |
|------------------|----------|
| Estimated length | 5080,000 |
| Width, W | 125,000 |
| Height, H | 25,500 |
| A | 25,000 |

MANUFACTURER

[SKF](#)