

PHG 16PJ810 SKF

Ribbed belt

TYPE: Special belts, Ribbed belts, Section PJ (SKF)

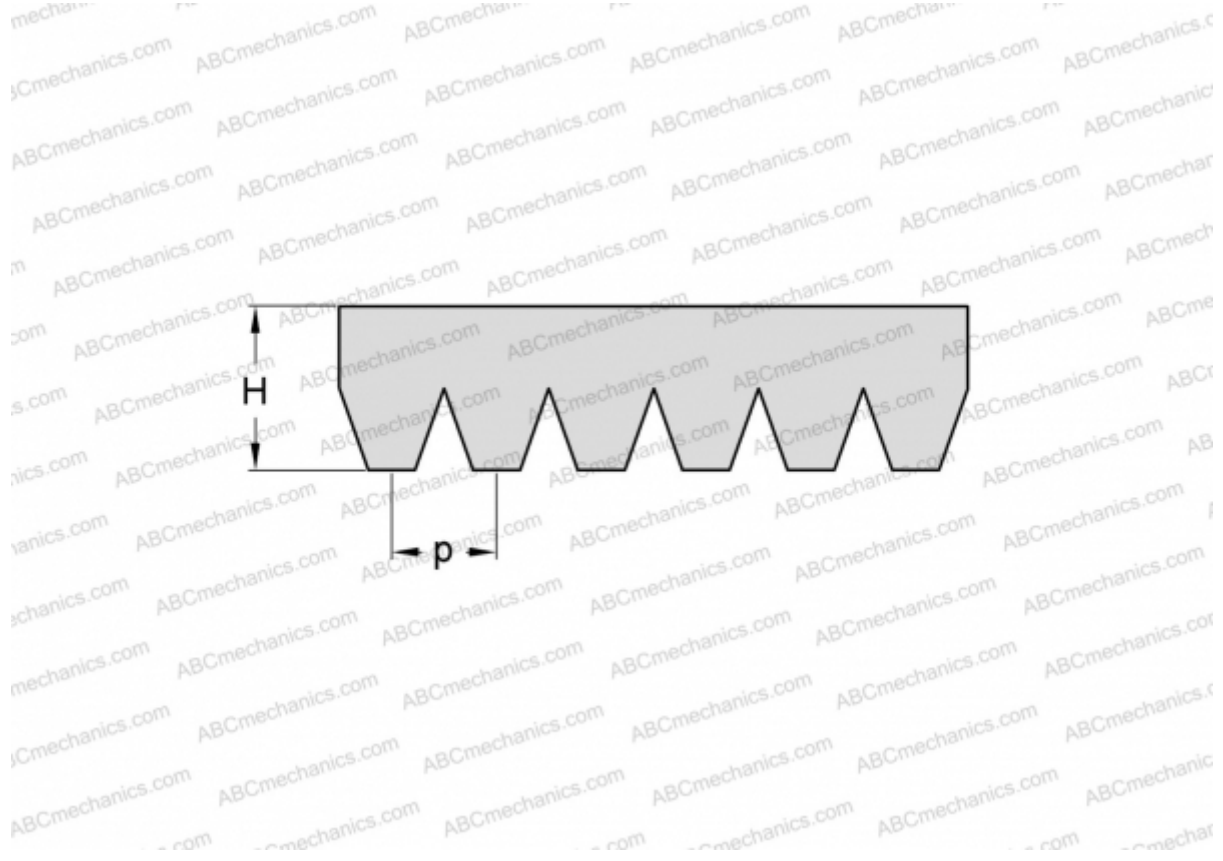

Technical specification

DIMENSIONS, MM

Estimated length	810,000
Width, W	37,440
Height, H	3,500
Pitch	2,340

MANUFACTURER [SKF](#)