

PHC 08B-1SLRX5M SKF

Xtra Performance SLR Chain

TYPE: Drive roller chain, Self lube, SKF

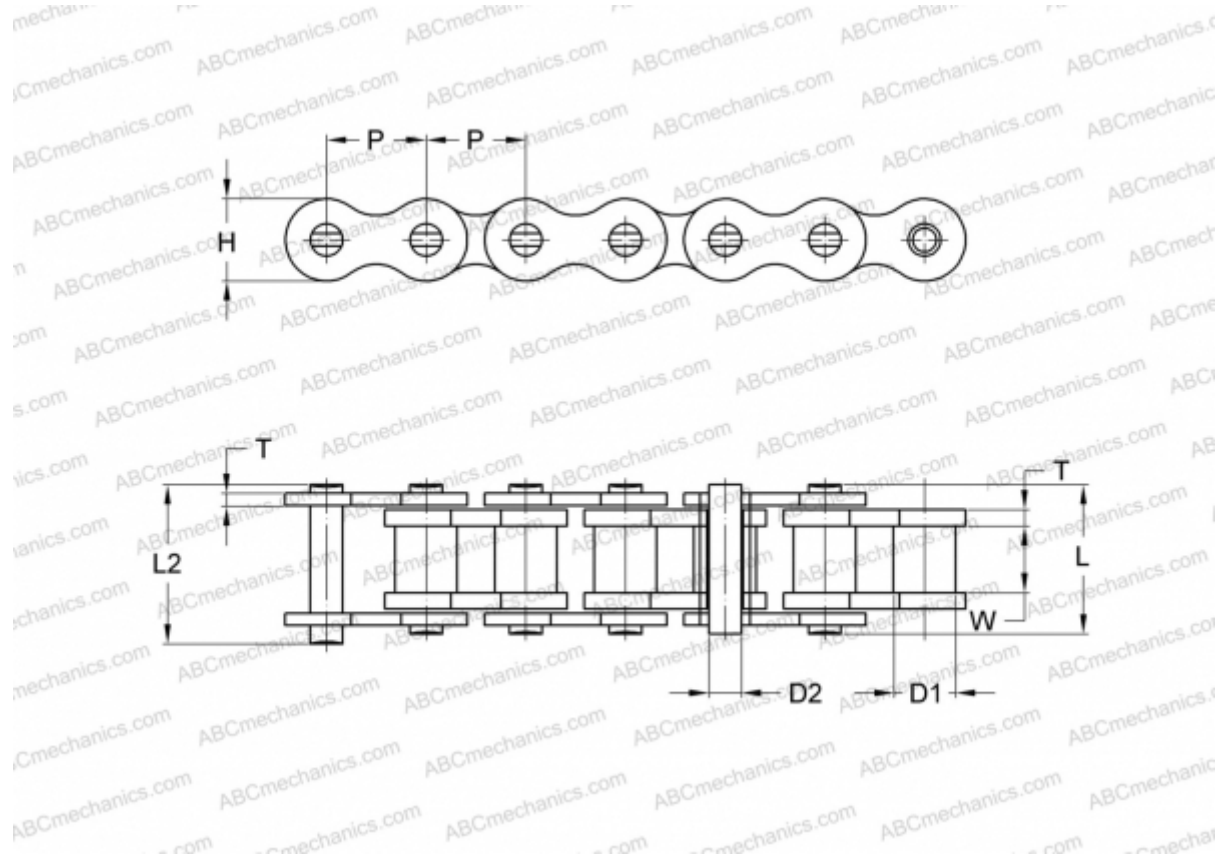

Technical specification

DIMENSIONS, MM

P	12,700
D1	8,510
W	7,750
D2	4,450
H	11,800
T	1,600
L	16,700
L2	18,200

WEIGHT, KG/M 0,690

MANUFACTURER [SKF](#)

DESIGNATION BS/ISO: 08B-1SLR