

PHC 12B-2SLRX5M SKF

Xtra Performance SLR Chain

TYPE: Drive roller chain, Self lube, SKF

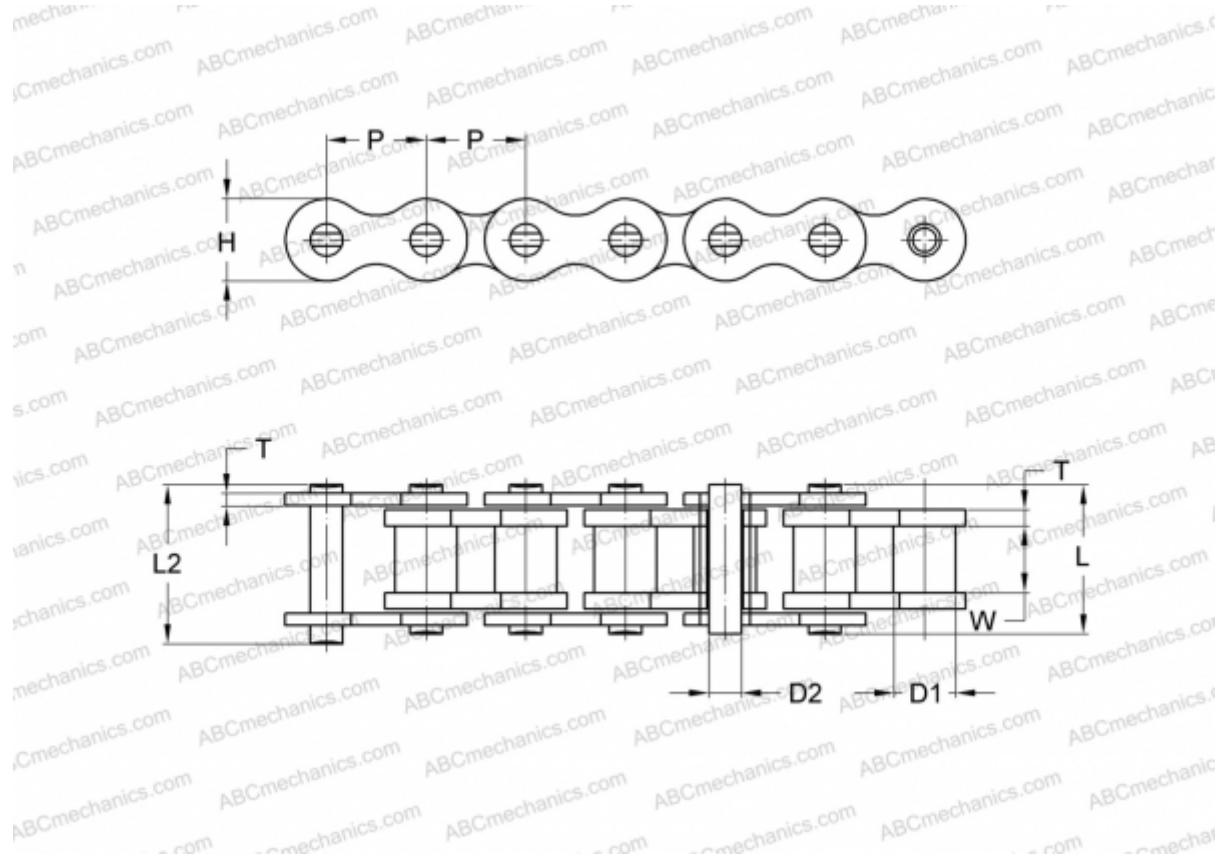

Technical specification

DIMENSIONS, MM

P	19,050
D1	12,070
W	11,680
D2	5,720
H	16,000
T	1,850
L	42,000
L2	43,600

WEIGHT, KG/M 2,310

MANUFACTURER [SKF](#)

DESIGNATION BS/ISO: 12B-2SLR