

PHC 16B-2SLRX5M SKF

Xtra Performance SLR Chain

TYPE: Drive roller chain, Self lube, SKF

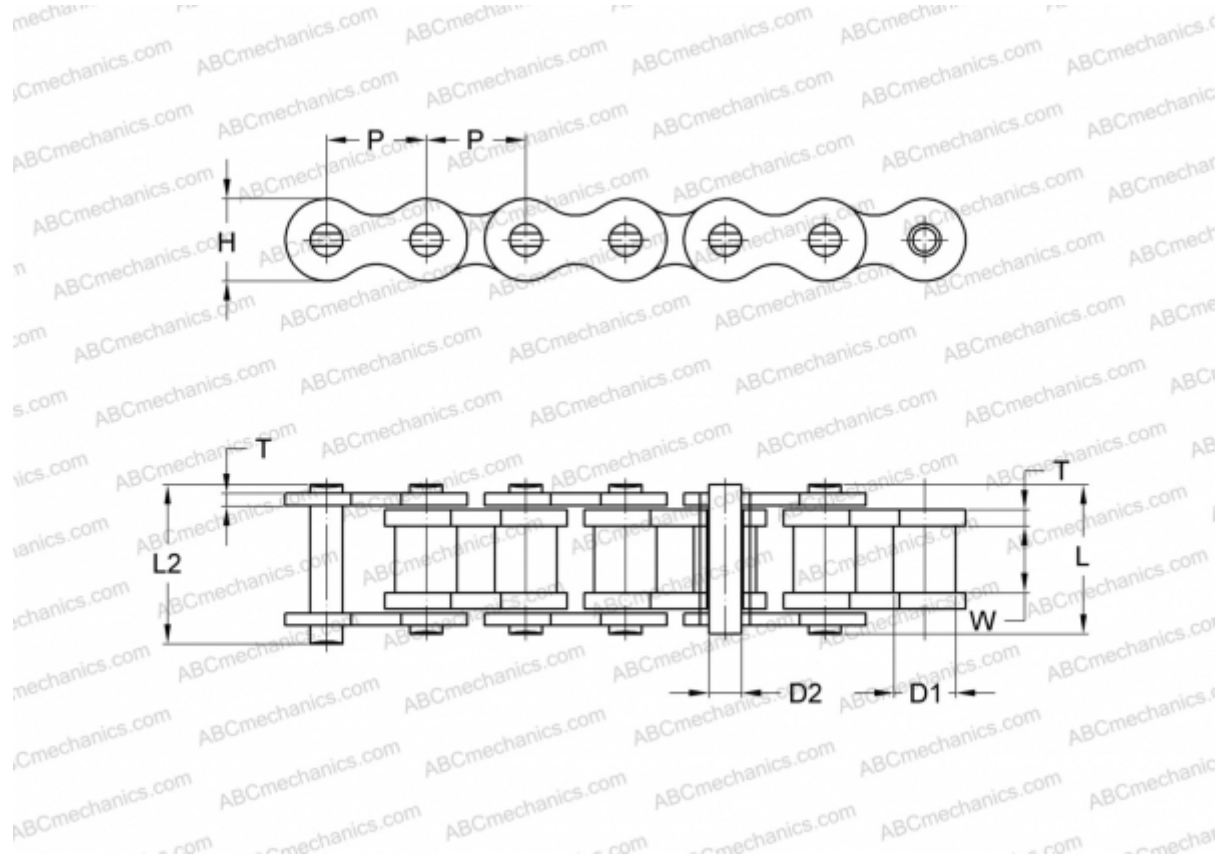

Technical specification

DIMENSIONS, MM

P	25,400
D1	15,880
W	17,020
D2	8,280
H	21,000
T	3,100
L	68,000
L2	69,300

WEIGHT, KG/M 5,420

MANUFACTURER [SKF](#)

DESIGNATION BS/ISO: 16B-2SLR