

PHC 40-1SLRX5M SKF

Xtra Performance SLR Chain

TYPE: Drive roller chain, Self lube, SKF

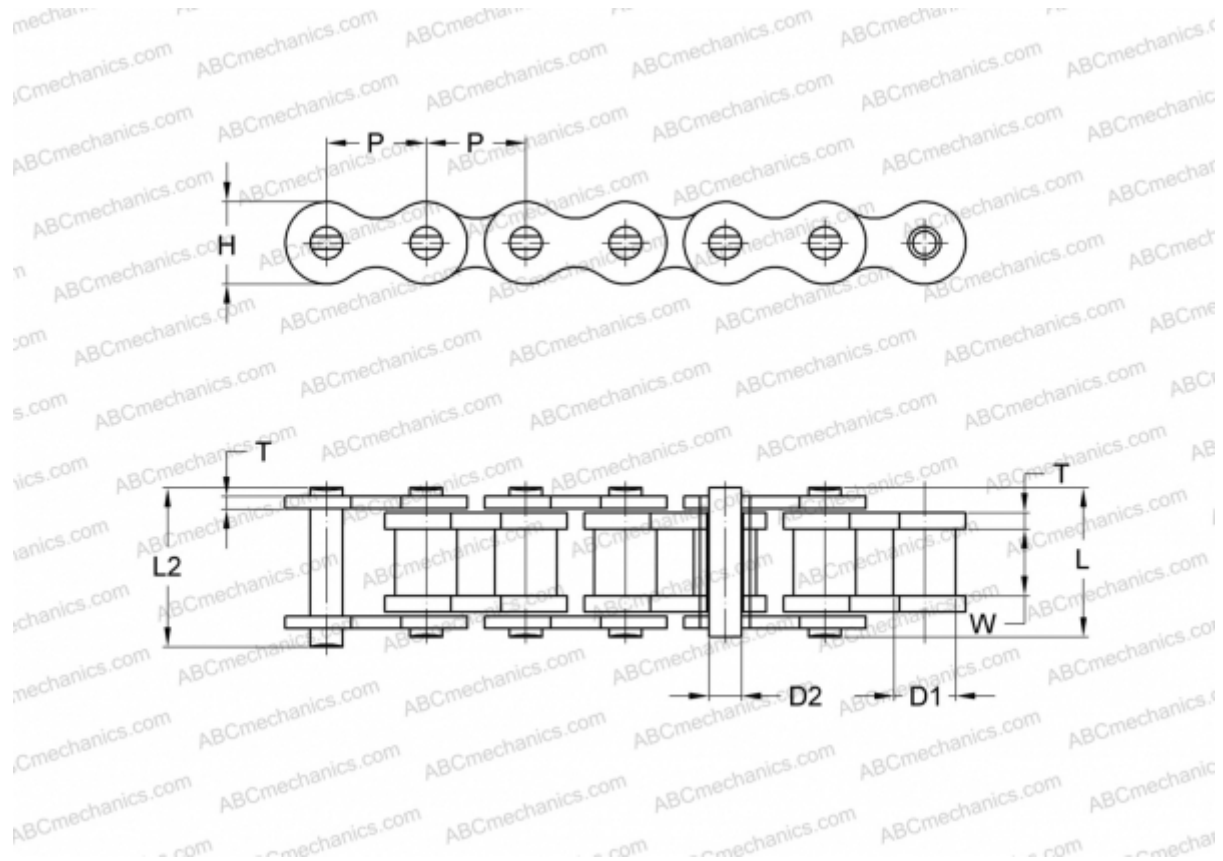

Technical specification

DIMENSIONS, MM

P	12,700
D1	7,950
W	7,850
D2	3,960
H	12,000
T	1,500
L	16,600
L2	17,800

WEIGHT, KG/M 0,620

MANUFACTURER [SKF](#)

DESIGNATION BS/ISO: 40-1SLR