

PHC 50-1SLRX5M SKF

Xtra Performance SLR Chain

TYPE: Drive roller chain, Self lube, SKF

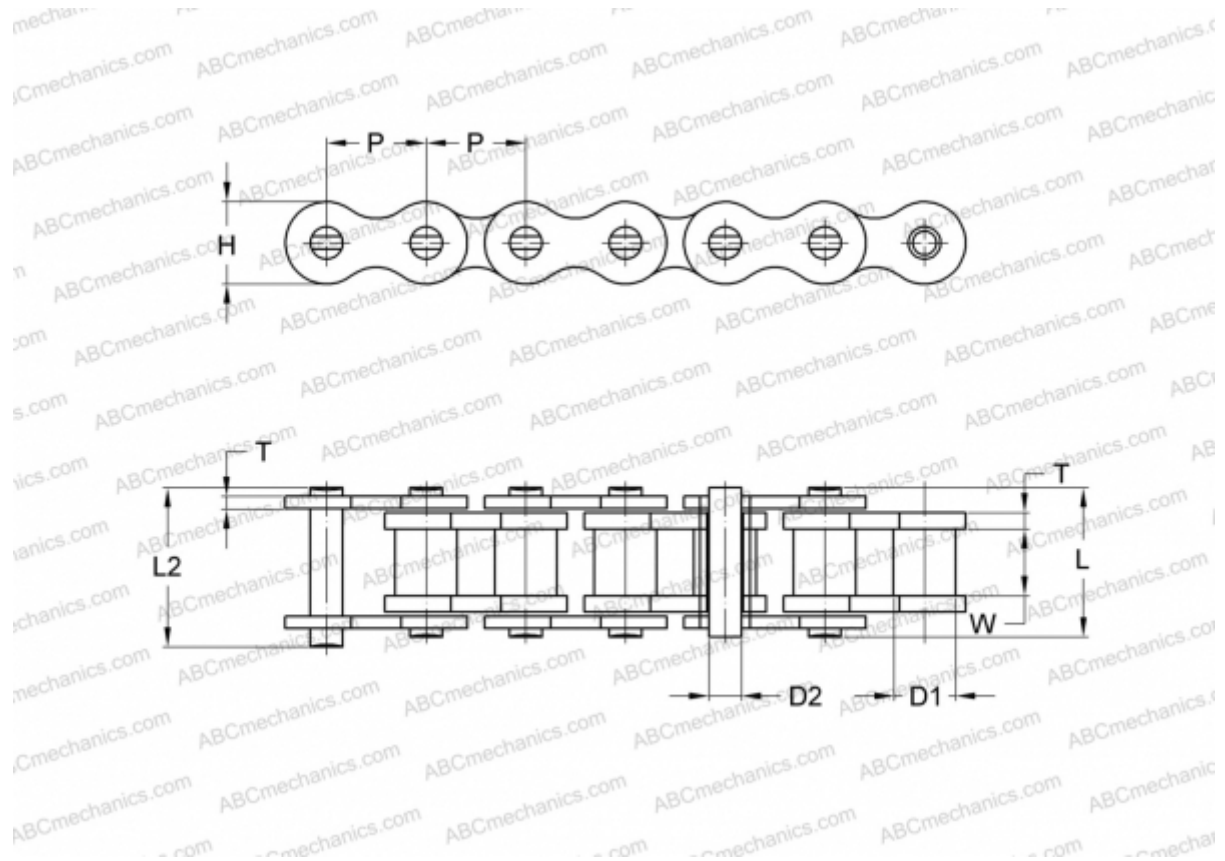

Technical specification

DIMENSIONS, MM

P	15,880
D1	10,160
W	9,400
D2	5,080
H	15,100
T	2,030
L	20,700
L2	22,200

WEIGHT, KG/M 1,020

MANUFACTURER [SKF](#)

DESIGNATION BS/ISO: 50-1SLR