

PHC 80-1SLRX5M SKF

Xtra Performance SLR Chain

TYPE: Drive roller chain, Self lube, SKF

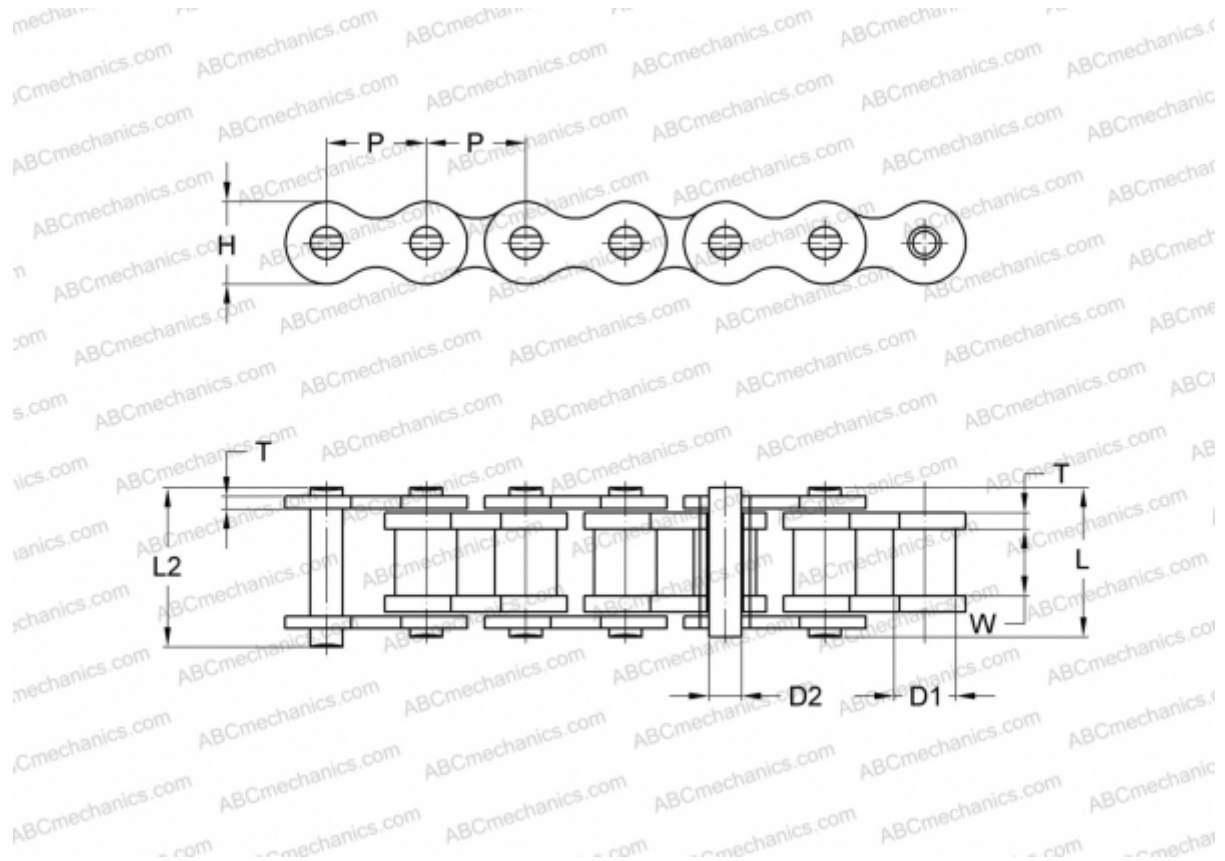

Technical specification

DIMENSIONS, MM

P	25,400
D1	15,880
W	15,750
D2	7,920
H	24,000
T	3,250
L	32,700
L2	35,000

WEIGHT, KG/M 2,600

MANUFACTURER [SKF](#)

DESIGNATION BS/ISO: 80-1SLR