

## PHC 60-2SLRX5M SKF

Xtra Performance SLR Chain

TYPE: Drive roller chain, Self lube, SKF

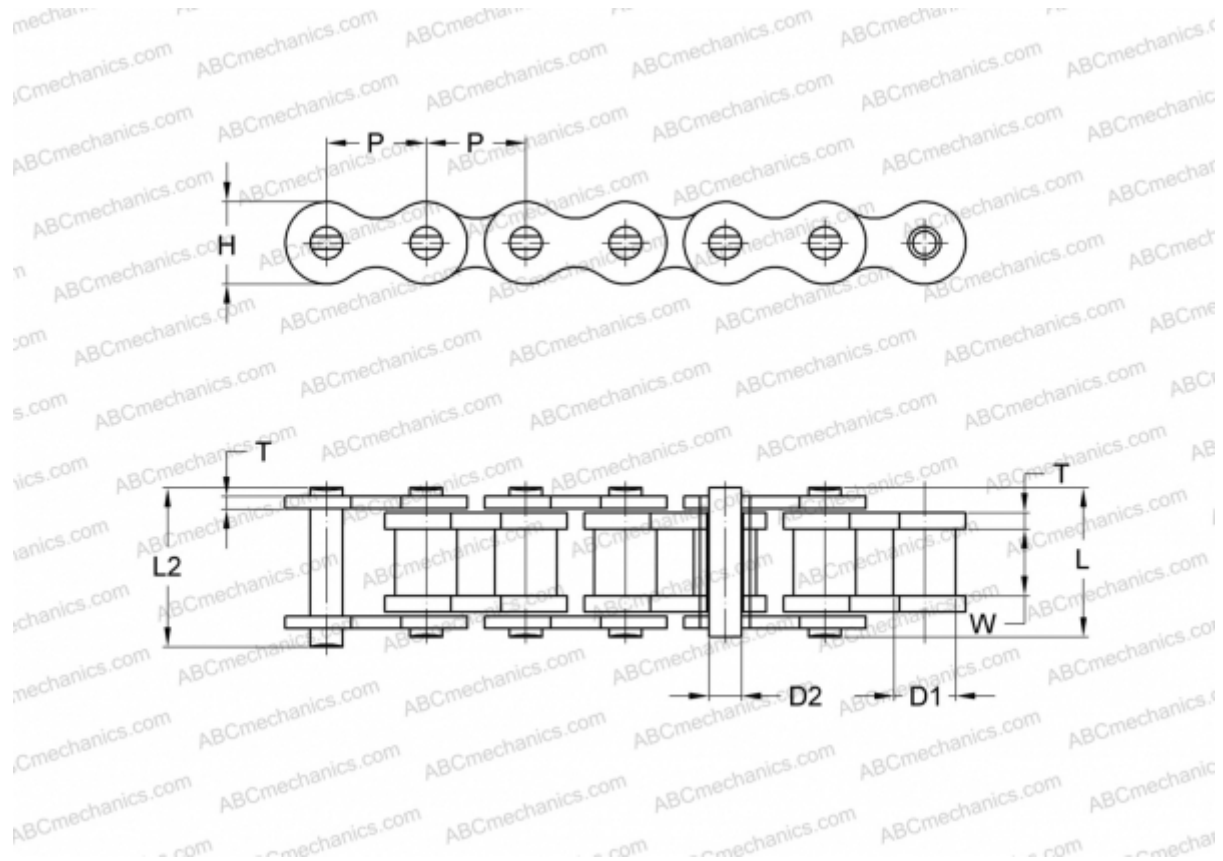

### Technical specification

#### DIMENSIONS, MM

P	19,050
D1	11,910
W	12,570
D2	5,940
H	18,000
T	2,420
L	50,300
L2	52,100

**WEIGHT, KG/M** 3,210

**MANUFACTURER** [SKF](#)

**DESIGNATION BS/ISO:** 60-2SLR