

PHC 16B-1SLRX10FT SKF

Xtra Performance SLR Chain

TYPE: Drive roller chain, Self lube, SKF

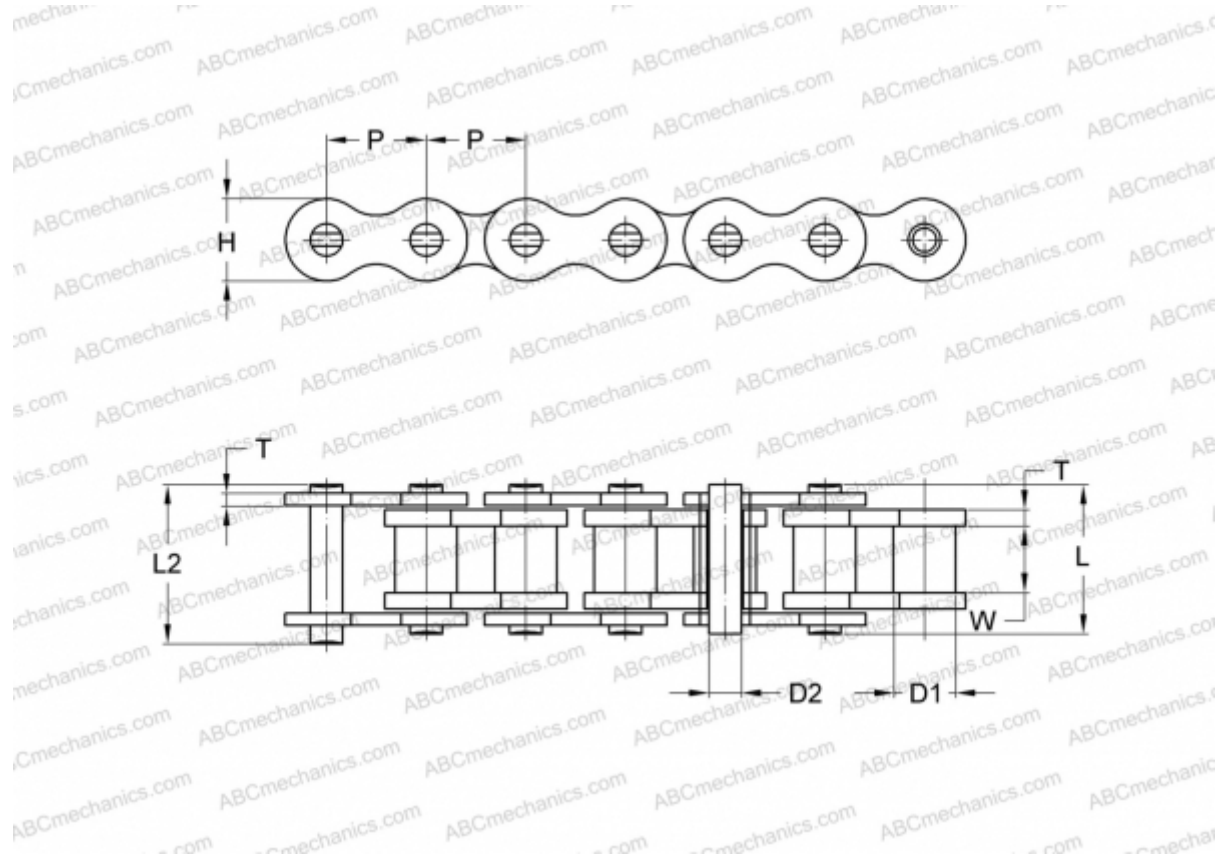

Technical specification

DIMENSIONS, MM

P	25,400
D1	15,880
W	17,020
D2	8,280
H	21,000
T	3,100
L	36,100
L2	37,400

WEIGHT, KG/M 2,710

MANUFACTURER [SKF](#)

DESIGNATION BS/ISO: 16B-1SLR