

## PHC 50-1SLRX10FT SKF

Xtra Performance SLR Chain

TYPE: Drive roller chain, Self lube, SKF

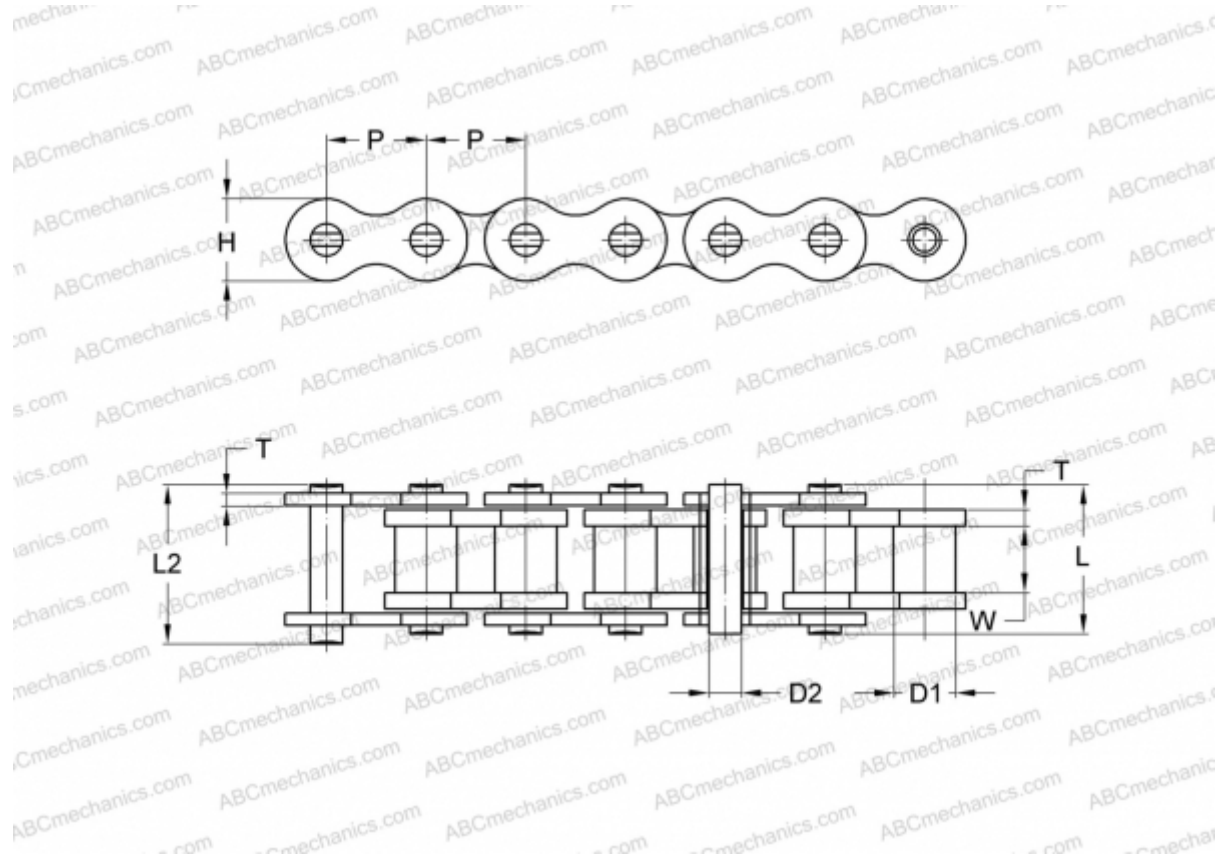

### Technical specification

#### DIMENSIONS, MM

P	15,880
D1	10,160
W	9,400
D2	5,080
H	15,100
T	2,030
L	20,700
L2	22,200

**WEIGHT, KG/M** 1,020

**MANUFACTURER** [SKF](#)

**DESIGNATION BS/ISO:** 50-1SLR