

## PHC C2100X5M SKF

Double pitch conveyor chain

TYPE: Conveyor chain, Double pitch, roller (SKF)

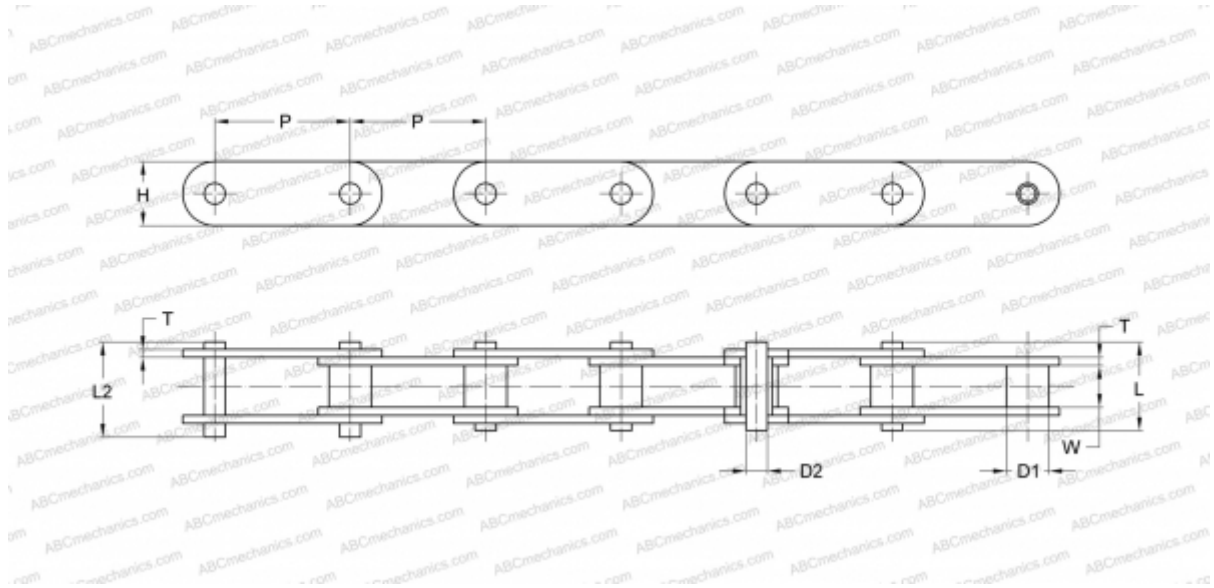

### Technical specification

#### DIMENSIONS, MM

P	63,500
D1	19,050
W	18,900
D2	9,530
H	30,000
T	4,000
L	40,400
L2	44,700

**WEIGHT, KG/M** 3,010

**MANUFACTURER** [SKF](#)

**DESIGNATION BS/ISO:** C220A

**DESIGNATION ANSI:** C2100