

## PHC C2100HX5M SKF

Double pitch conveyor chain

TYPE: Conveyor chain, Double pitch, roller (SKF)

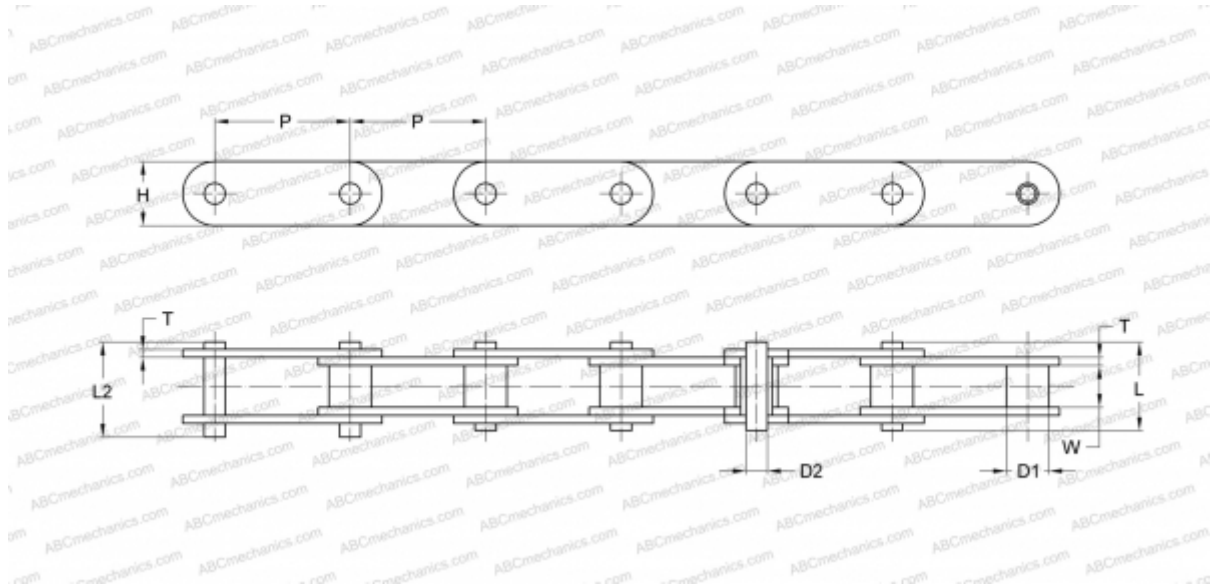

### Technical specification

#### DIMENSIONS, MM

P	63,500
D1	19,050
W	18,900
D2	9,530
H	30,000
T	4,800
L	43,600
L2	46,900

**WEIGHT, KG/M** 3,560

**MANUFACTURER** [SKF](#)

**DESIGNATION BS/ISO:** C220AH

**DESIGNATION ANSI:** C2100H