

## PHC C2120HX5M SKF

Double pitch conveyor chain

TYPE: Conveyor chain, Double pitch, roller (SKF)

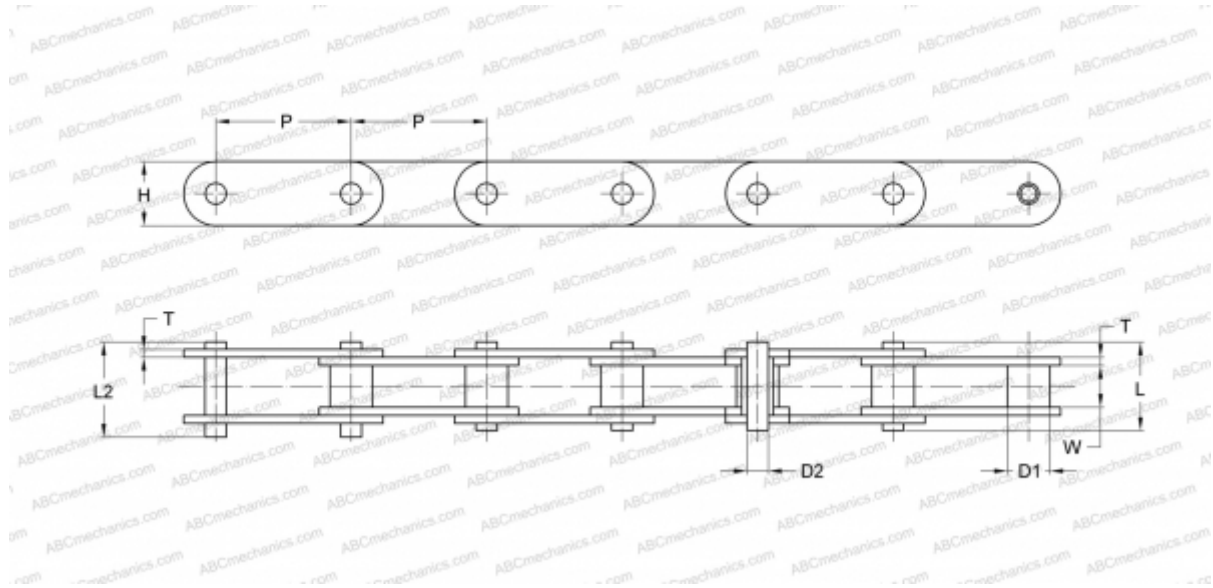

### Technical specification

#### DIMENSIONS, MM

P	76,200
D1	22,230
W	25,220
D2	11,100
H	35,700
T	5,600
L	53,500
L2	57,500

**WEIGHT, KG/M** 5,260

**MANUFACTURER** [SKF](#)

**DESIGNATION BS/ISO:** C224AH

**DESIGNATION ANSI:** C2120H