

PHC C2040X10FT SKF

Double pitch conveyor chain

TYPE: Conveyor chain, Double pitch, roller (SKF)

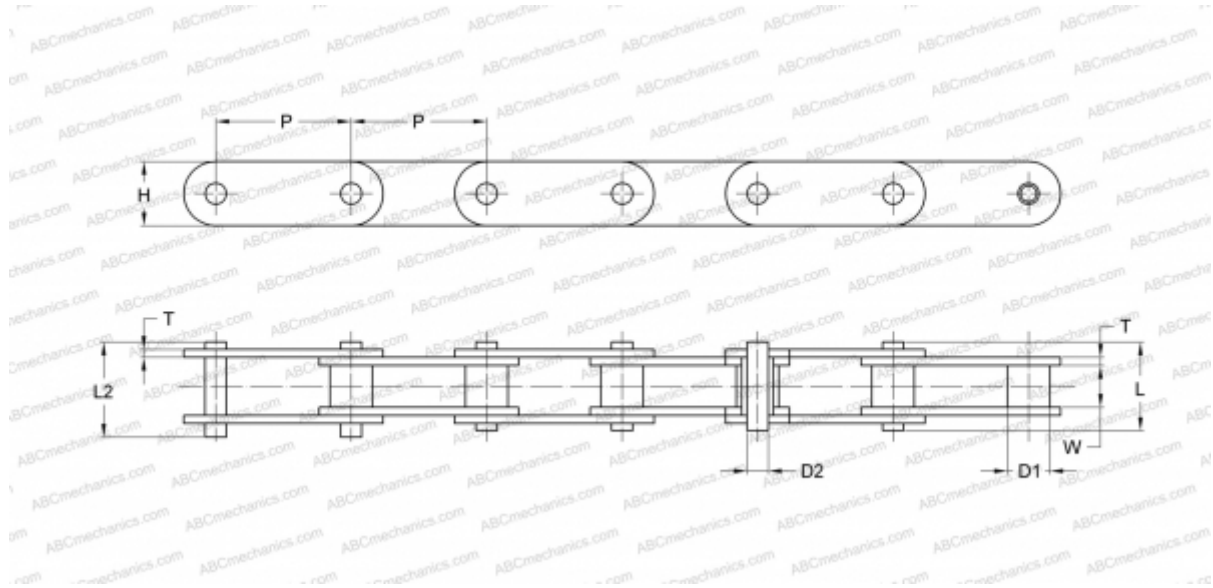

Technical specification

DIMENSIONS, MM

P	25,400
D1	7,950
W	7,850
D2	3,960
H	12,000
T	1,500
L	16,600
L2	17,800

WEIGHT, KG/M 0,500

MANUFACTURER [SKF](#)

DESIGNATION BS/ISO: C208A

DESIGNATION ANSI: C2040