

## PHC C2040HX10FT SKF

Double pitch conveyor chain

TYPE: Conveyor chain, Double pitch, roller (SKF)

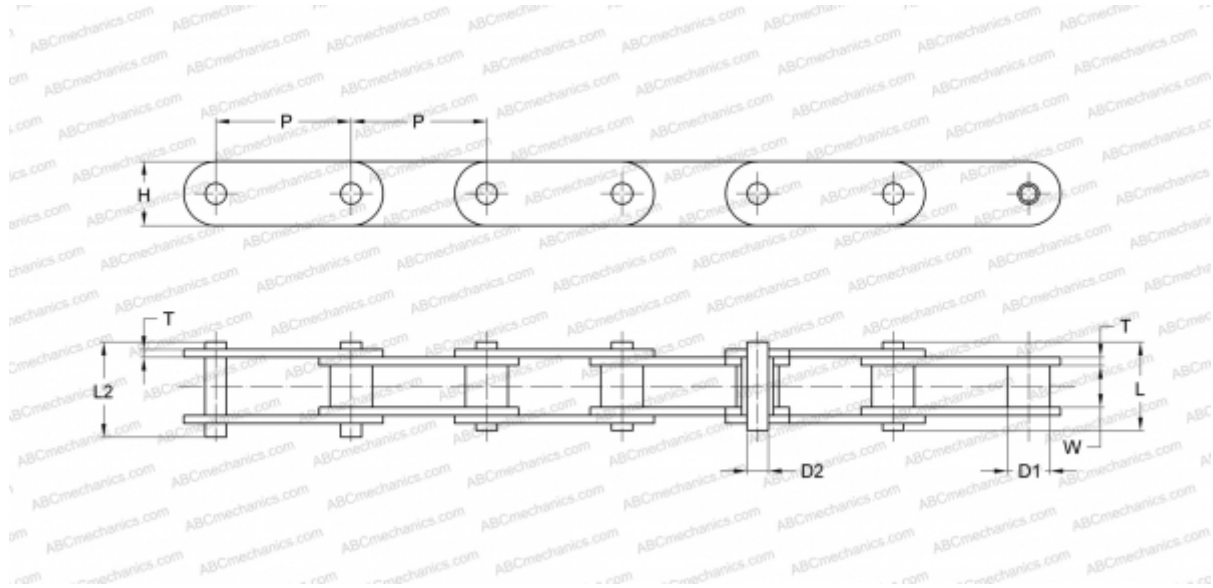

### Technical specification

#### DIMENSIONS, MM

P	25,400
D1	7,950
W	7,850
D2	3,960
H	12,000
T	2,030
L	18,800
L2	19,900

**WEIGHT, KG/M** 0,650

**MANUFACTURER** [SKF](#)

**DESIGNATION BS/ISO:** C208AH

**DESIGNATION ANSI:** C2040H