

PHC C2050X10FT SKF

Double pitch conveyor chain

TYPE: Conveyor chain, Double pitch, roller (SKF)

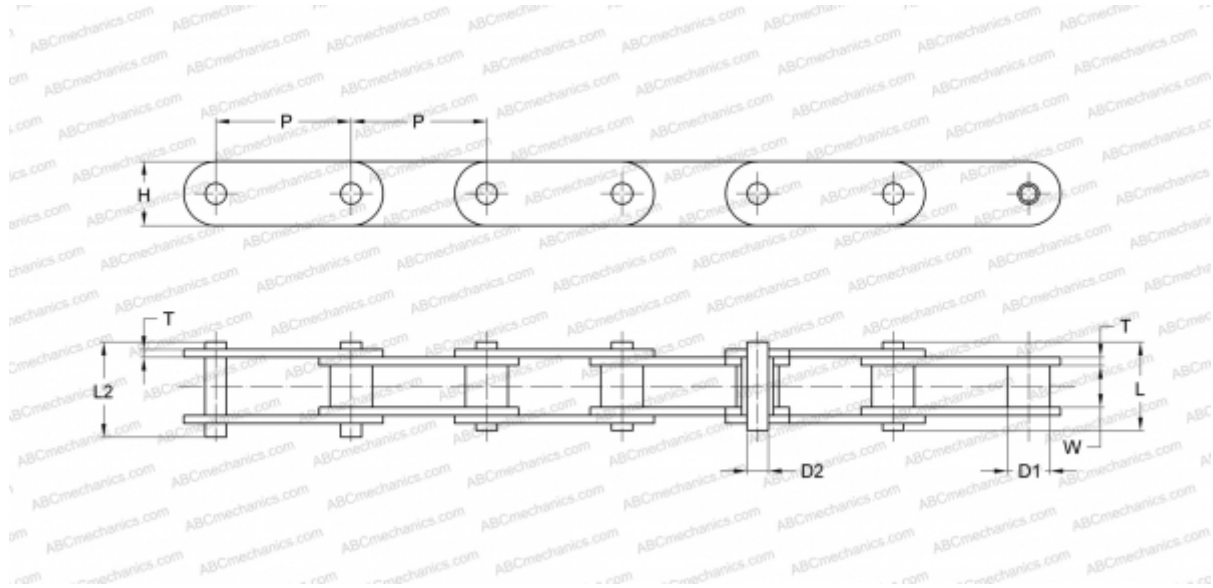

Technical specification

DIMENSIONS, MM

P	31,750
D1	10,160
W	9,400
D2	5,080
H	15,000
T	2,030
L	20,700
L2	22,200

WEIGHT, KG/M 0,780

MANUFACTURER [SKF](#)

DESIGNATION BS/ISO: C210A

DESIGNATION ANSI: C2050