

PHC C2060X10FT SKF

Double pitch conveyor chain

TYPE: Conveyor chain, Double pitch, roller (SKF)

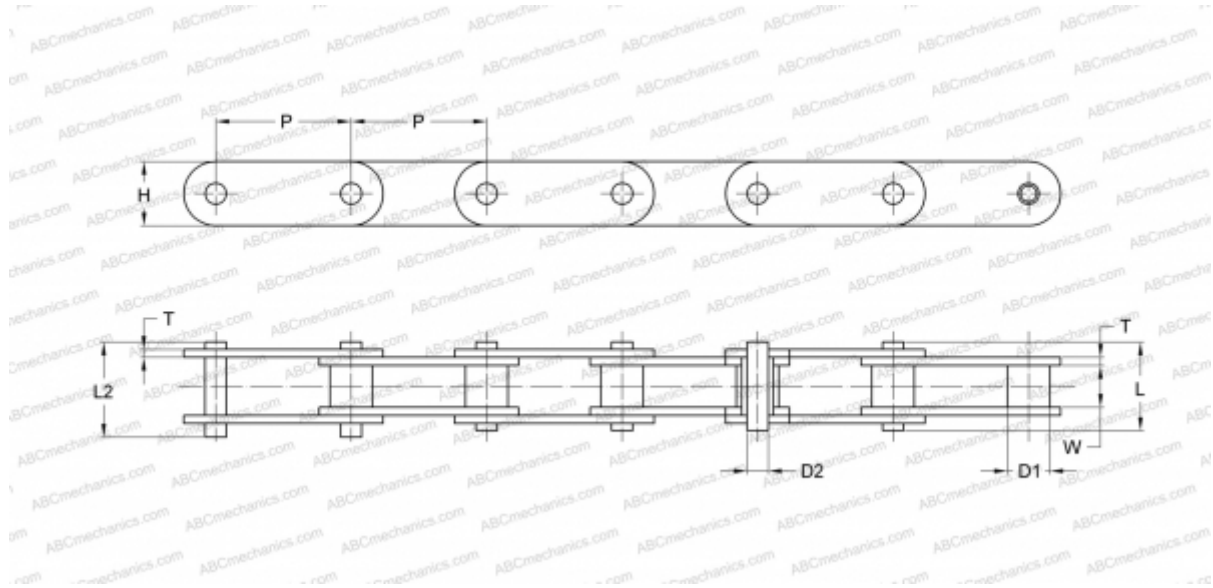

Technical specification

DIMENSIONS, MM

P	38,100
D1	11,910
W	12,570
D2	5,940
H	18,000
T	2,420
L	25,900
L2	27,700

WEIGHT, KG/M 1,120

MANUFACTURER [SKF](#)

DESIGNATION BS/ISO: C212A

DESIGNATION ANSI: C2060