

## PHC C2060HX10FT SKF

Double pitch conveyor chain

TYPE: Conveyor chain, Double pitch, roller (SKF)

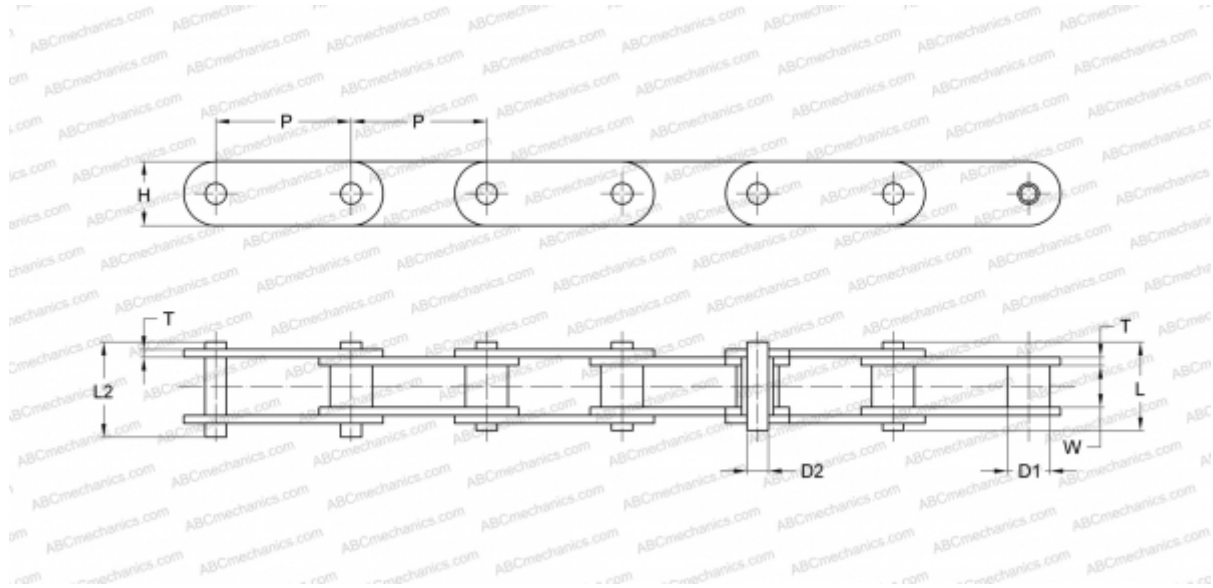

### Technical specification

#### DIMENSIONS, MM

P	38,100
D1	11,910
W	12,570
D2	5,940
H	18,000
T	3,250
L	29,200
L2	31,600

**WEIGHT, KG/M** 1,440

**MANUFACTURER** [SKF](#)

**DESIGNATION BS/ISO:** C212AH

**DESIGNATION ANSI:** C2060H