

PHC C2100X10FT SKF

Double pitch conveyor chain

TYPE: Conveyor chain, Double pitch, roller (SKF)

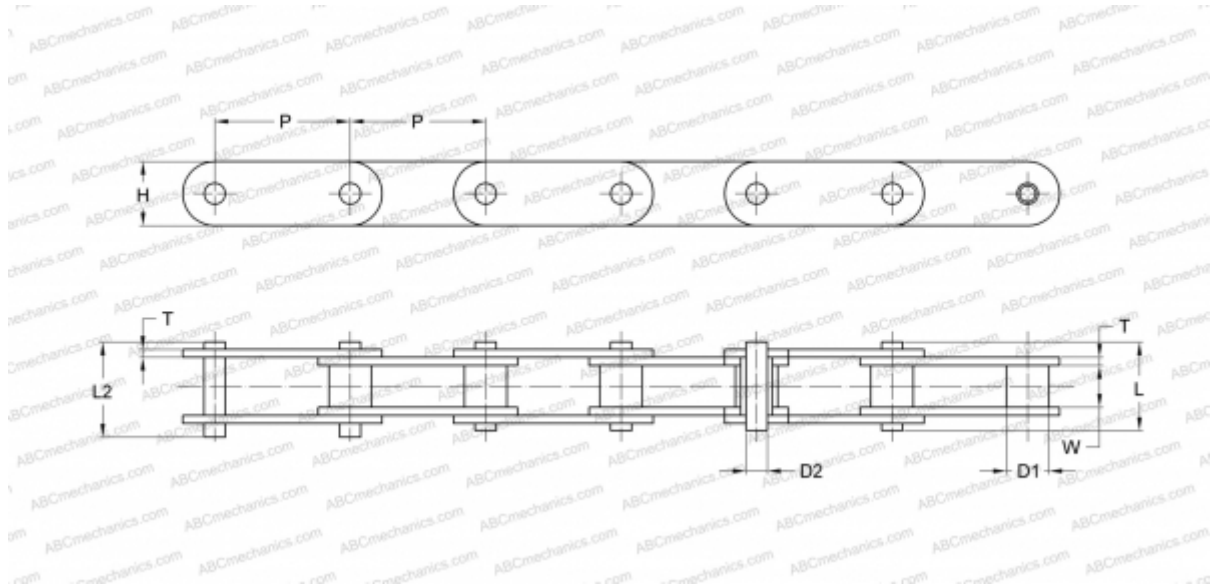

Technical specification

DIMENSIONS, MM

P	63,500
D1	19,050
W	18,900
D2	9,530
H	30,000
T	4,000
L	40,400
L2	44,700

WEIGHT, KG/M 3,010

MANUFACTURER [SKF](#)

DESIGNATION BS/ISO: C220A

DESIGNATION ANSI: C2100