

PHC C2100HX10FT SKF

Double pitch conveyor chain

TYPE: Conveyor chain, Double pitch, roller (SKF)

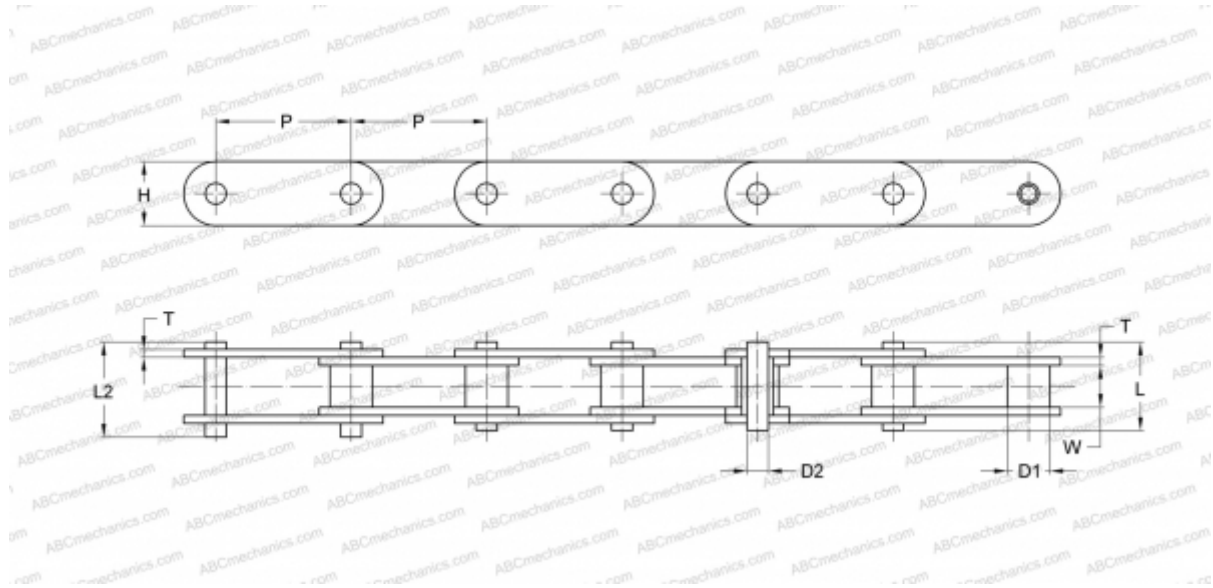

Technical specification

DIMENSIONS, MM

P	63,500
D1	19,050
W	18,900
D2	9,530
H	30,000
T	4,800
L	43,600
L2	46,900

WEIGHT, KG/M 3,560

MANUFACTURER [SKF](#)

DESIGNATION BS/ISO: C220AH

DESIGNATION ANSI: C2100H