

PHC C2120X10FT SKF

Double pitch conveyor chain

TYPE: Conveyor chain, Double pitch, roller (SKF)

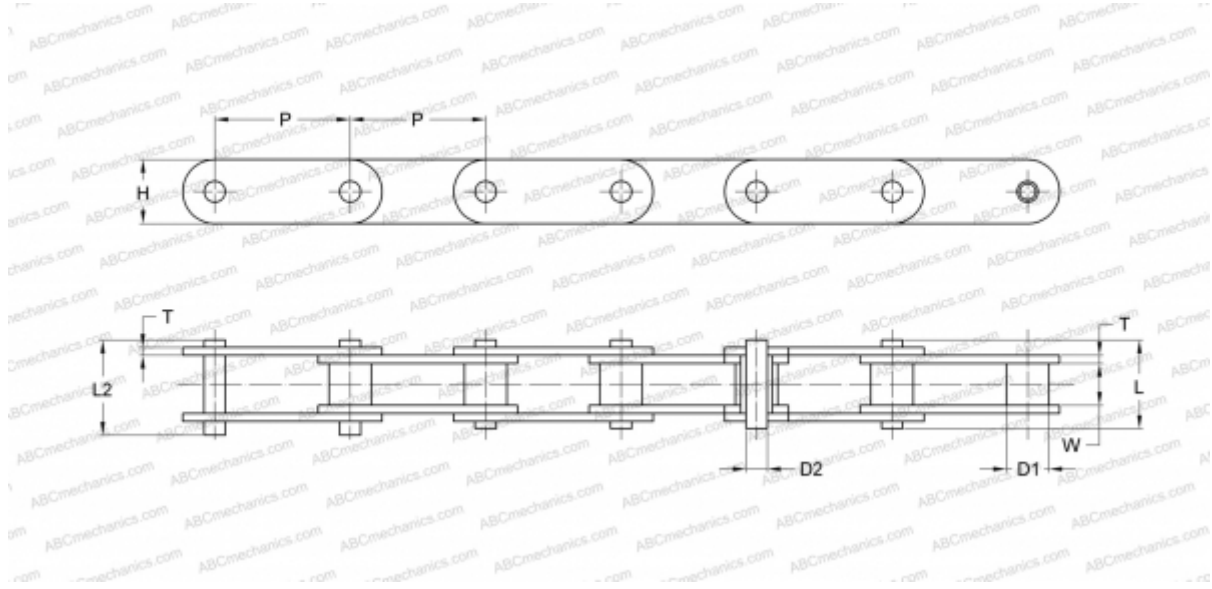

Technical specification

DIMENSIONS, MM

P	76,200
D1	22,230
W	25,220
D2	11,100
H	35,700
T	4,800
L	50,300
L2	54,300

WEIGHT, KG/M 4,660

MANUFACTURER [SKF](#)

DESIGNATION BS/ISO: C224A

DESIGNATION ANSI: C2120